

# micro **SYSTEM**

## Installation Instructions

### Type C Boilers

G.C.N: 41-116-06

41-116-07

LEAVE THESE INSTRUCTIONS  
WITH THE END-USER



*The code of practice for the installation,  
commissioning & servicing of central heating systems*

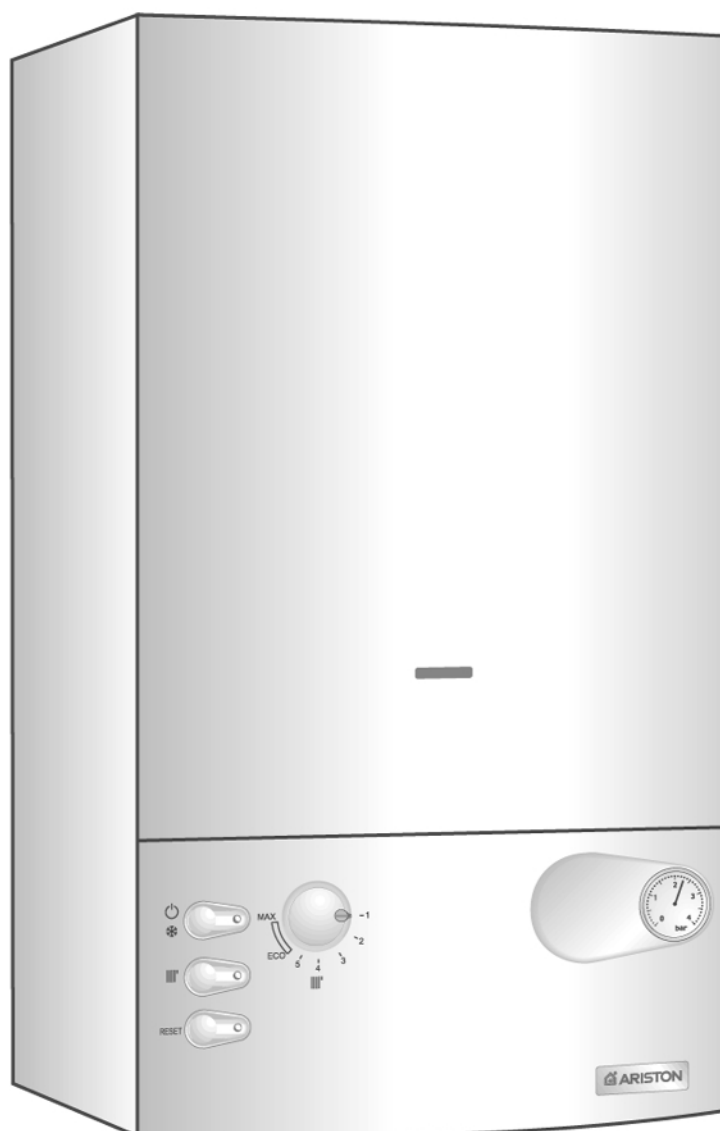

# **TABLE OF CONTENTS**

## **1. GENERAL INFORMATION**

- 1.1 GENERAL INSTRUCTIONS
- 1.2 OVERALL VIEW

## **2. INSTALLATION**

- 2.1 REFERENCE STANDARDS
- 2.2 SITING THE APPLIANCE
- 2.3 OVERALL DIMENSIONS
- 2.4 CLEARANCES
- 2.5 MOUNTING THE APPLIANCE
- 2.6 ELECTRICAL CONNECTION
- 2.7 GAS CONNECTION
- 2.8 WATER CONNECTIONS
- 2.9 FLUE CONNECTION
- 2.10 ROOM THERMOSTAT CONNECTION
- 2.11 ELECTRICAL DIAGRAMS
- 2.12 GAS AND WATER CIRCUITS

## **3. D.H.W. STORAGE CYLINDER**

- 3.1 2 PORT AND 3 PORT VALVE INSTALLATIONS
- 3.2 DOMESTIC HOT WATER PRIORITY KIT

## **4. COMMISSIONING**

- 4.1 INITIAL PREPARATION
- 4.2 CONTROL PANEL
- 4.3 REMOVING THE FRONT PANEL
- 4.4 INITIAL START UP
- 4.5 OPERATIONAL ADJUSTMENTS
- 4.6 COMBUSTION ANALYSIS
- 4.7 FUME DISCHARGE MONITORING
- 4.8 DRAINING THE SYSTEM

## **5. GAS ADJUSTMENTS**

### **GAS ADJUSTMENT TABLE**

- 5.1 CHANGING THE TYPE OF GAS

## **6. MAINTENANCE**

## **7. TECHNICAL INFORMATION**

## 1. GENERAL INFORMATION

This manual is an integral and essential part of the product. It should be kept with the appliance so that it can be consulted by the user and our authorised personnel.

Please carefully read the instructions and notices about the unit contained in this manual, as they provide important information regarding the safe installation, use and maintenance of the product.

For operating instructions please consult the separate User's Manual.

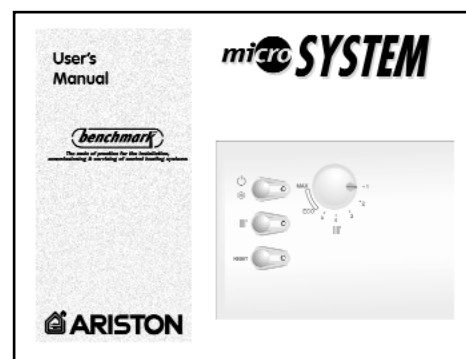

### 1.1 GENERAL INSTRUCTIONS

Read the instructions and recommendations in these Installation Instructions carefully to ensure proper installation, use and maintenance of the appliance.

Keep this manual in a safe place. You may need it for your own reference while our Servicing Centre technicians or your installer may need to consult it in the future.

This is an appliance for the production of central heating (C.H.).

This appliance **must be used only** for the purpose for which it is designed. The manufacturer declines all liability for damage caused by improper or negligent use.

No asbestos or other hazardous materials have been used in the fabrication of this product.

**Before connecting** the appliance, check that the information shown on the data plate and the table in section 7 comply with the electric, water and gas mains of the property. You will find the data plate on the reverse of the control panel.

The gas with which this appliance operates is also shown on the label at the bottom of the boiler.

**Do not** install this appliance in a damp environment or close to equipment which spray water or other liquids.

**Do not place** objects on the appliance.

**Do not allow** children or inexperienced persons to use the appliance without supervision.

If you smell gas in the room, **do not turn on** light switches, use the telephone or any other object which might cause sparks.

Open doors and windows immediately to ventilate the room.

Shut the gas mains tap (at or adjacent to the gas meter) or the valve of the gas cylinder and call your Gas Supplier immediately.

If you are going away for a long period of time, remember to shut the mains gas tap or the gas cylinder valve.

**Always disconnect** the appliance either by unplugging it from the mains or turning off the mains switch before cleaning the appliance or carrying out maintenance.

**In the case of faults or failure**, switch off the appliance and turn off the gas tap. Do not tamper with the appliance.

For repairs, call your local Authorised Servicing Centre and request the use of original spare parts. For in-guarantee repairs contact MTS (GB) Limited.

**Check** the following at least once a year:

- 1 - Check the seals for the water connections; replace any faulty seals.
- 2 - Check the gas seals; replace any faulty gas seals.
- 3 - Visual check of the entire unit.

- 4 - Visual check of the combustion process or analysis of combustion by-products (see section 4.5) and cleaning of the burner if needed.
- 5 - If called for by point. 3, dismantling and cleaning of the combustion chamber.
- 6 - If called for by point. 4, dismantling and cleaning of the burner jets.
- 7 - Visual check of the primary heat exchanger:
  - check for overheating in the blade assembly;
  - clean the exhaust fan if needed.
- 8 - Adjustment of the flow rate of the gas: flow rate for lighting, partial load and full load.
- 9 - Check of the heating safety systems:
  - safety device for maximum temperature (overheat thermostat);
  - safety device for maximum pressure (safety valve).
- 10- Check of the gas safety systems:
  - safety device for lack of gas or flame ionisation (detection electrode);
  - safety device for gas cock.
- 11- Check of the electrical connection (make sure it complies with the instructions in the manual).
- 12- General check of the combustion by-products of the discharge/ventilation system.
- 13- Check of the general performance of the unit.

**FIG. 1.0**

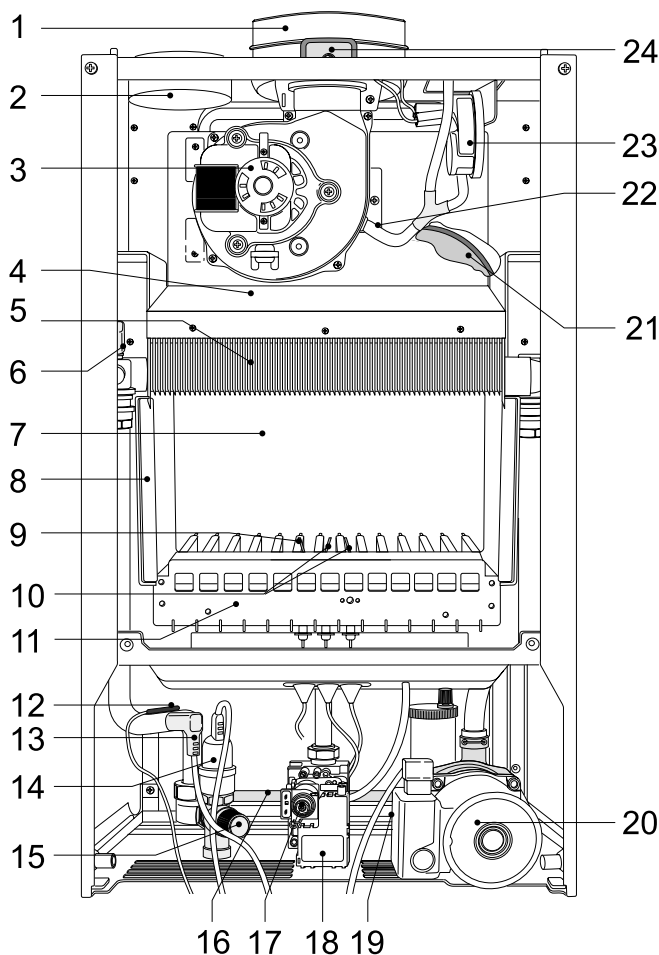

## 1.2 OVERALL VIEW

### LEGEND:

- |     |   |
|-----|---|
| 1.  | Flue connector                                    |
| 2.  | Air intake for twin pipe flue systems             |
| 3.  | Fan   |
| 4.  | Combustion chamber hood                           |
| 5.  | Main heat exchanger                               |
| 6.  | Safety thermostat                                 |
| 7.  | Combustion chamber                                |
| 8.  | Combustion chamber insulation panel               |
| 9.  | Detection electrode                               |
| 10. | Ignition electrodes                               |
| 11. | Burner  |
| 12. | Regulation thermostat                             |
| 13. | Frost thermostat                                  |
| 14. | Pump pressure switch                              |
| 15. | Safety valve (3 bar)                              |
| 16. | Automatic By-pass                                 |
| 17. | Gas valve   |
| 18. | Spark generator                                   |
| 19. | Boiler drain valve                                |
| 20. | Circulation pump with automatic air release valve |
| 21. | Expansion vessel                                  |
| 22. | Air pressure take-off point                       |
| 23. | Air pressure switch                               |
| 24. | Combustion analysis points                        |

## 2. INSTALLATION

The technical information and instructions provided herein below are intended for the installer so that the unit may be installed correctly and safely.

### 2.1 REFERENCE STANDARDS

The installation and initial start up of the boiler must be by a CORGI Registered Installer in compliance with the installation standards currently in effect, as well as with any and all local health and safety standards i.e. CORGI .

***This appliance must be installed by a competent installer in accordance with current Gas Safety (installation & use) Regulations.***

The installation of this appliance must be in accordance with the relevant requirements of the current Gas Safety (installation & use) Regulations, the Local Building Regulations, the current I.E.E. Wiring Regulations, the byelaws of the local water authority, and in Scotland, in accordance with the Building Standards (Scotland) Regulation and Health and Safety document No. 635 "Electricity at work regulations 1989".

Installation should also comply with the following British Standard Codes of Practice:

BS 7593:1992	Treatment of water in domestic hot water central heating systems
BS 5546:1990	Installation of hot water supplies for domestic purposes
BS 5440-1:1990	Flues
BS 5440-2:1989	Air supply
BS 5449:1990	Forced circulation hot water systems
BS 6789:1987	Installation of gas fired hot water boilers of rated input not exceeding 60kW
BS 6891:1989	Installation of low pressure gas pipe up to 28mm
BS 7671:1992	IEE wiring regulations
BS 4814:1990	Specification for expansion vessels
BS 5482:1994	Installation of LPG

### 2.2 SITING THE APPLIANCE

The appliance may be installed in any room or indoor area, although particular attention is drawn to the requirements of the current I.E.E. Wiring Regulations, and in Scotland, the electrical provisions of the Building Regulations applicable in Scotland, with respect to the installation of the appliance in a room containing a bath or shower.

**Where a room-sealed appliance is installed in a room containing a bath or shower the appliance and any electrical switch or appliance control, utilising mains electricity should be situated so that it cannot be touched by a person using the bath or shower.**

The location must permit adequate space for servicing and air circulation around the appliance as indicated in paragraph 2.4.

The location must permit the provision of an adequate flue and termination.

For unusual locations special procedures may be necessary.

BS 6798-1987 gives detailed guidance on this aspect.

A compartment used to enclose the appliance must be designed specifically for this purpose. No specific ventilation requirements are needed for the installation within a cupboard.

This appliance is not suitable for outdoor installation.

***The type C appliances (in which the combustion circuit, air vent intake and combustion chamber are air-tight with respect to the room in which the appliance is installed) can be installed in any type of room.***

Secondary ventilation is not required with this boiler. The boiler must be installed on a solid, permanent wall to prevent access from the rear.

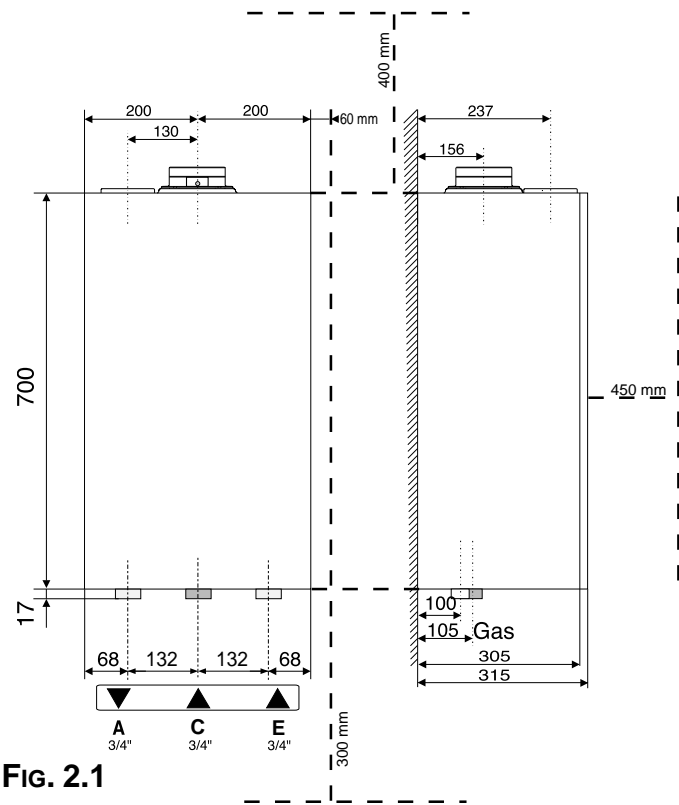

**FIG. 2.1**

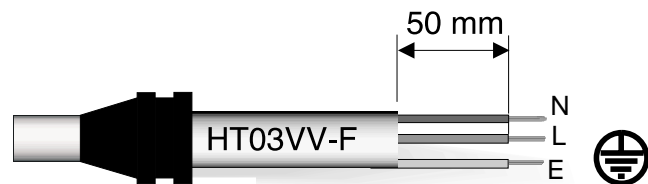

**FIG. 2.2**

## 2.3 OVERALL DIMENSIONS

### LEGEND:

- A = Central Heating Flow (3/4")
- C = Gas Inlet (3/4")
- E = Central Heating Return (3/4")
- (mm) = Clearances

## 2.4 CLEARANCES

In order to allow for access to the interior of the boiler for maintenance purposes, the boiler must be installed in compliance with the minimum clearances indicated in **FIG. 2.1**

## 2.5 MOUNTING THE APPLIANCE

Fasten the boiler in place using the template and anchors supplied with the unit. It is highly recommended that a spirit level be used to position the boiler so that it is perfectly level.

For additional information, please consult the instructions contained in the connection kit and the flue kit.

## 2.6 ELECTRICAL CONNECTION

For safety purposes, have a competent person carefully check the electrical system in the property, as the manufacturer will not be held liable for damage caused by the failure to earth the appliance properly or by anomalies in the supply of power. Make sure that the residential electrical system is adequate for the maximum power absorbed by the unit, which is indicated on the rating plate. In addition, check that the section of cabling is appropriate for the power absorbed by the boiler.

The boiler operates with alternating current, as indicated in the technical information table in section 7, where the maximum absorbed power is also indicated. Make sure that the connections for the neutral and live wires correspond to the indications in the diagram. The appliance electrical connections are situated on the reverse of the control panel under the inspection cover (see the servicing manual for further information)

### IMPORTANT!

In the event that the power supply cord must be changed, replace it with one with the same specifications. Make the connections to the terminal board located within the control panel, as follows:

- The yellow-green wire should be connected to the terminal marked with the "⊕" symbol;
- The blue wire should be connected to the terminal marked "N";
- The brown wire should be connected to the terminal

marked "L".

Note: The diagrams for the electrical system are indicated in section 2.12.

**Warning, this appliance must be earthed.**

External wiring to the appliance must be carried out by a competent person and be in accordance with the current I.E.E. Regulations and applicable local regulations. The *microSYSTEM* range of boilers are supplied for connection to a 230 V- 50 Hz supply.

**The supply must be fused at 3 A.**

The method of connection to the electricity supply must facilitate complete electrical isolation of the appliance, by the use of a fused double pole isolator having a contact separation of at least 3 mm in all poles or alternatively, by means of a 3 A fused three pin plug and unswitched shuttered socket outlet both complying with BS 1363.

The point of connection to the Electricity supply must be readily accessible and adjacent to the appliance unless the appliance is installed in a bathroom when this must be sited outside the bathroom (see section 2.2).

**2.7 GAS CONNECTION**

The local gas region contractor connects the gas meter to the service pipe. If the gas supply for the boiler serves other appliances ensure that an adequate supply is available both to the boiler and the other appliances when they are in use at the same time.

Pipe work must be of an adequate size. Pipes of a smaller size than the boiler inlet connection should not be used.

**2.8 WATER CONNECTIONS**

**FIG. 2.4**

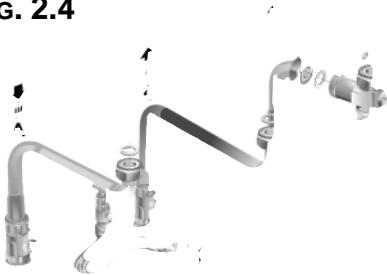

**VIEW OF THE BOILER CONNECTIONS**

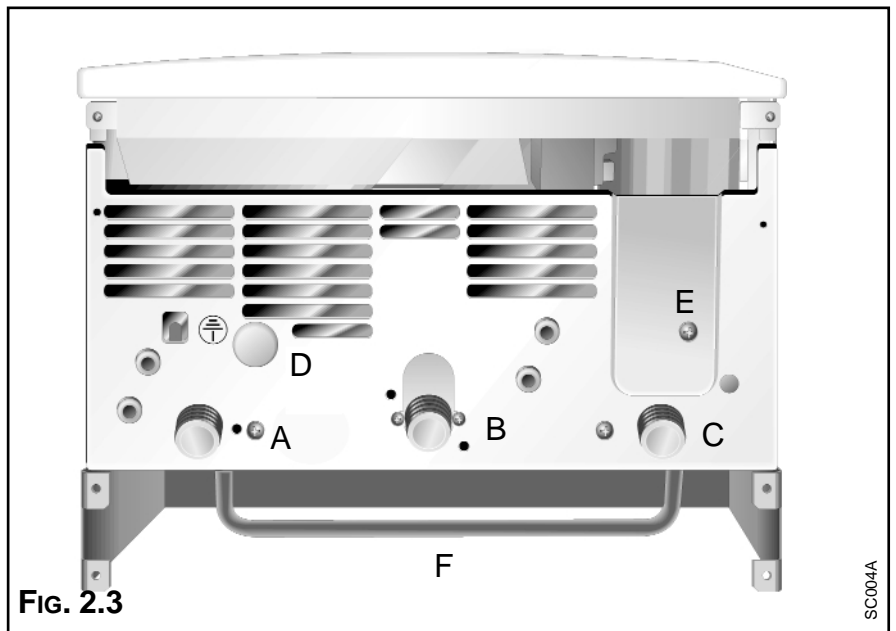

**LEGEND:**

- A = Central Heating Flow
- C = Gas Inlet
- E = Central Heating Return
- F = Safety Valve
- G = Pump transportation screw  
(remove before igniting the boiler)
- H = Automatic By-pass pipe

**CENTRAL HEATING**

Detailed recommendations are given in BS 6798:1987 and BS 5449-1:1990, the following notes are given for general guidance.

*PIPE WORK:*

Copper tubing to BS EN 1057:1996 is recommended for water pipes. Jointing should be either with capillary soldered or compression fittings. Where possible pipes should have a gradient to ensure air is carried naturally to air release points and water flows naturally to drain taps.

The appliance has a built-in automatic air release valve, however it should be ensured as far as possible that the appliance heat exchanger is not a natural collecting point for air.

Except where providing useful heat, pipes should be insulated to prevent heat loss and avoid freezing.

Particular attention should be paid to pipes passing through ventilated spaces in roofs and under floors.

*BY-PASS:*

The appliance includes an automatic by-pass valve, which protects the main heat exchanger in case of reduced or interrupted water circulation through the heating system, due to the closing of thermostatic valves or radiator valves within the system.

*SYSTEM DESIGN:*

This boiler is suitable only for sealed systems.

*Drain Cocks:*

These must be located in accessible positions to permit the draining of the whole system and should be fitted at all low points. The taps must be at least 15mm nominal size and manufactured in accordance with BS 2870:1980.

*SAFETY VALVE DISCHARGE:*

The discharge should terminate facing downward on the exterior of the building in a position where discharging (possibly boiling water & steam) will not create danger or nuisance, but in an easily visible position, and not cause damage to electrical components and wiring.

The discharge must not be over an entrance or a window or any other type of public access.

*AIR RELEASE POINTS:*

These must be fitted at all high points where air naturally collects and must be sited to facilitate complete filling of the system.

The appliance has an integral sealed expansion vessel to accommodate the increase of water volume when the system is heated.

It can accept up to 6 litre (1.3 gal) of expansion water. If the heating circuit has an unusually high water content, calculate the total expansion and add an additional sealed expansion vessel with adequate capacity. This should be located on the return pipe work as close as possible to the pump inlet.

*MAINS WATER FEED - CENTRAL HEATING:*

There must be no direct connection to the mains water supply even through a non-return valve, without the approval of the Local Water Authority.

*FILLING:*

A temporary method for initially filling the system and replacing lost water during servicing and initial filling (in accordance with current Water Regulations), is provided as an integral part of the connection kit (see **Fig. 2.4**). The flexible hose must be removed once the system has been filled.

**RESIDUAL HEAD OF THE BOILER**

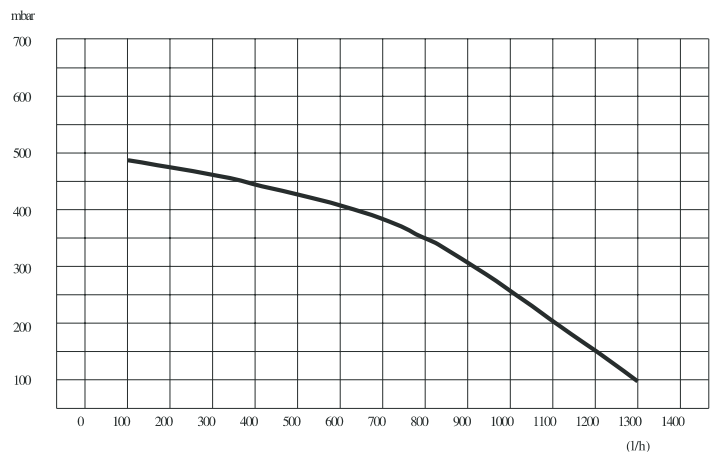



## 2.9 FLUE CONNECTIONS

### FLUE SYSTEM

The provision for satisfactory flue termination must be made in accordance with BS 5440-1.

The appliance must be installed so that the flue terminal is exposed to outside air. The terminal must not discharge into another room or space such as an outhouse or lean-to.

It is important that the position of the terminal allows a free passage of air across it at all times.

The terminal should be located with due regard for the damage or discolouration that might occur on buildings in the vicinity.

In cold or humid weather water vapour may condense on leaving the flue terminal.

The effect of such "pluming" must be considered.

If the terminal is less than 2 metres above a balcony, above ground or above a flat roof to which people have access, then a suitable terminal guard must be fitted. When ordering a terminal guard, quote the appliance model number.

A suitable terminal guard is available from:

### TOWER FLUE COMPONENTS

Morley Road

Tonbridge

Kent TN9 1RA

The minimum acceptable spacing from the terminal to obstructions and ventilation openings are specified in **Fig. 2.5**.

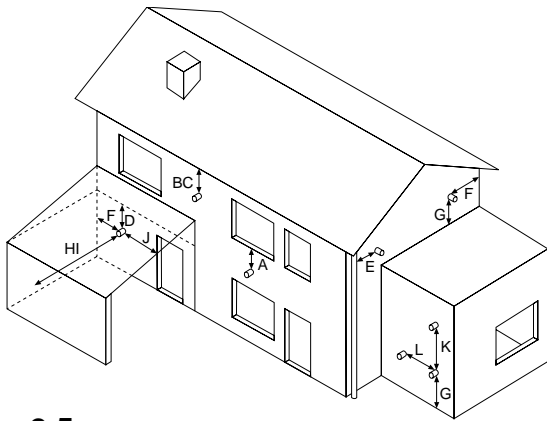

**Fig. 2.5**

TERMINAL POSITION	mm
A - Directly below an openable window or other opening	300
B - Below gutters, soil pipes or drain pipes	75
C - Below eaves	200
D - Below balconies or car-port roof	200
E - From vertical drain pipes and soil pipes	75
F - From internal or external corners	300
G - Above ground or balcony level	300
H - From a surface facing a terminal	600
I - From a terminal facing a terminal	1200
J - From an opening in the car port (e.g. door, window) into dwelling	1200
K - Vertically from a terminal in the same wall	1500
L - Horizontally from a terminal in the same wall	300

The boiler is designed to be connected to a coaxial flue discharge system.

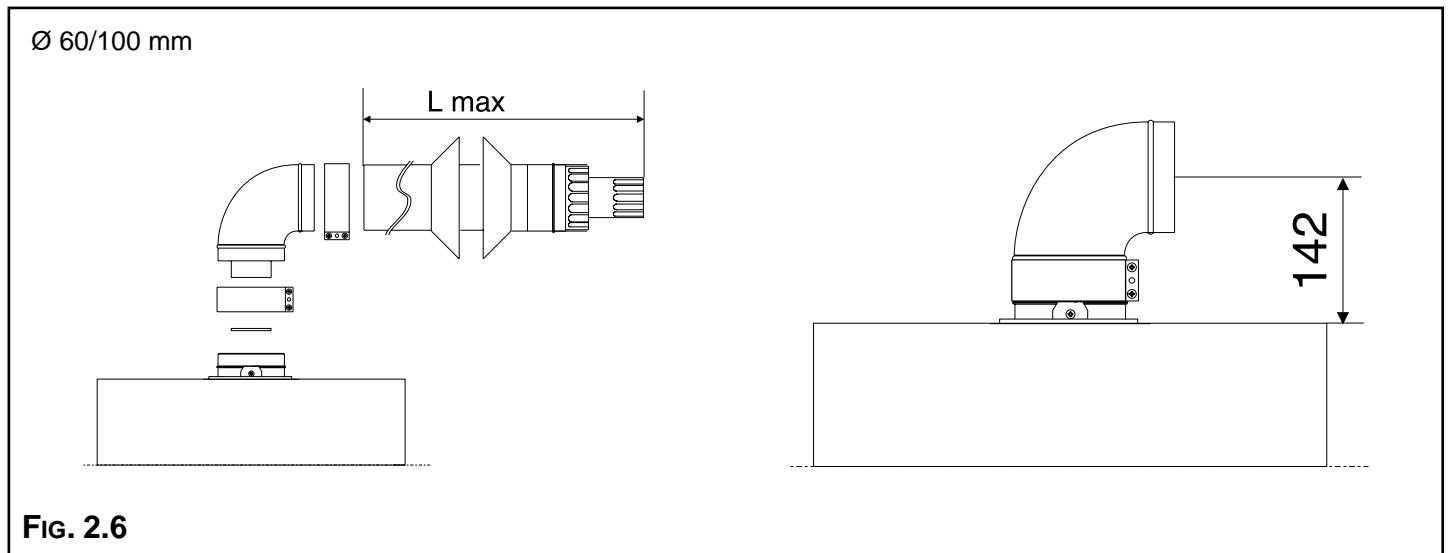
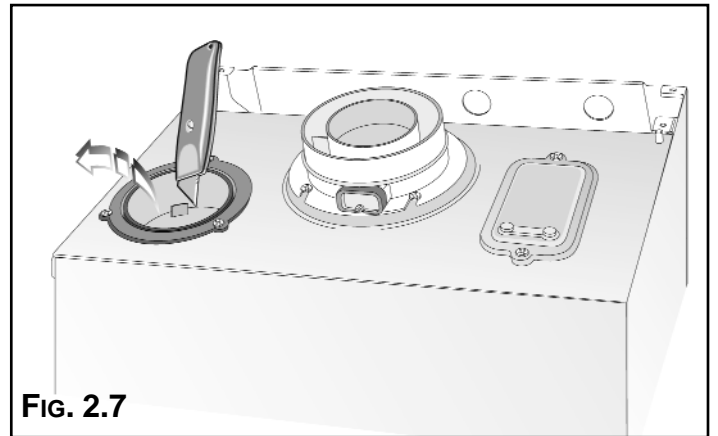

**Fig. 2.6**

In addition, it is also possible to use a split (twin pipe) system by fitting a special adaptor to the flue connector and using the aperture for the air vent intake located on the top part of the combustion chamber.

To utilise the air intake it is necessary to:

1. Remove the bottom of the air intake by cutting it with a suitable knife (see **FIG. 2.7**);
2. Insert the elbow into the air intake until it reaches the lower end. (There is no need to use gaskets or sealing compounds).



**FIG. 2.7**

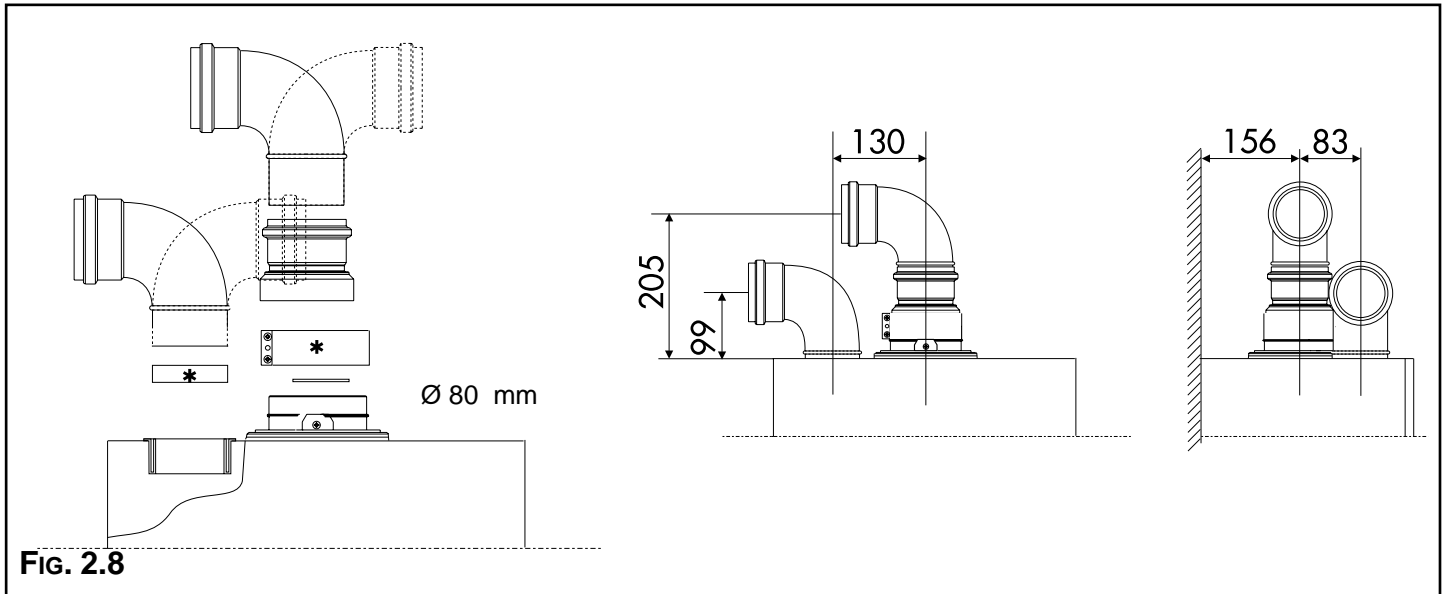

**FIG. 2.8**

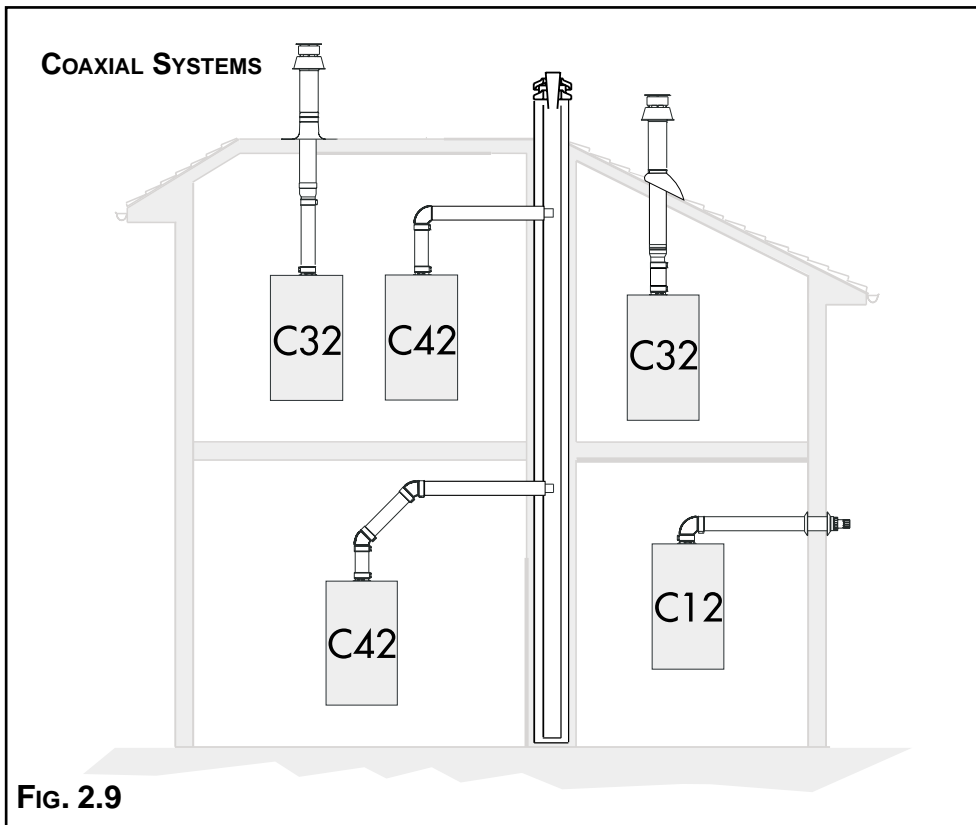

**FIG. 2.9**

**IMPORTANT!**

For all flue systems, a restrictor must always be inserted into the boiler's flue connector; the restrictor must be Ø 46 or Ø 41 in diameter depending on the length of piping indicated in TABLE 2.1.

FIG 2.9 and FIG 2.10 illustrate some of the various designs for coaxial or twin pipe flue systems.

For further information on discharge/ventilation accessories, see the **FLUE PIPE ACCESSORIES MANUAL**.

TABLE 2.1

miac SYSTEM 21 RFFI	Exhaust Type	Restrictor ø 46 mm	Maximum Extension Exhaust/Air	Risk of Condensation Forming			
				Piping not insulated		Piping insulated	
				ø 46 restrictor	NO restrictor	ø 46 restrictor	NO restrictor
Coaxial Systems ø 60/100	C12 (xx) C32 (xx) C42 (xx)	L min = 0.5 m L max = 1 m	L = 4 m	NONE	NONE	NONE	NONE

miac SYSTEM 28 RFFI	Exhaust Type	Restrictor ø 41 mm	Maximum Extension Exhaust/Air	Risk of Condensation Forming			
				Piping not insulated		Piping insulated	
				ø 41 restrictor	NO restrictor	ø 41 restrictor	NO restrictor
Coaxial Systems ø 60/100	C12 (xx) C32 (xx) C42 (xx)	L min = 0.5 m L max = 1 m	L = 4 m	NONE	NONE	NONE	NONE

miac SYSTEM 21 RFFI	Exhaust Type	Restrictor ø 46 mm	Maximum Extension Exhaust/Air	Risk of Condensation Forming			
				Piping not insulated		Piping insulated	
				ø 46 restrictor	NO restrictor	ø 46 restrictor	NO restrictor
Twin Pipe Systems ø 80/80	C12 (xy) C32 (xy) C42 (xy)	L max = 25 m	34 m 34 m 34 m	3.0 m	4.5 m	12.5 m	16.0 m
	C52 (xy) C82 (xy)		31 m	3.3 m	4.8 m	14.0 m	17.8 m

miac SYSTEM 28 RFFI	Exhaust Type	Restrictor ø 41 mm	Maximum Extension Exhaust/Air	Risk of Condensation Forming			
				Piping not insulated		Piping insulated	
				ø 41 restrictor	NO restrictor	ø 41 restrictor	NO restrictor
Twin Pipe Systems ø 80/80	C12 (xy) C32 (xy) C42 (xy)	L max = 38 m	62 m 62 m 62 m	8 m	11 m	19 m	31 m
	C52 (xy) C82 (xy)		54 m	8 m	11 m	19 m	31 m

L = Sum of the total length of exhaust + air intake piping.

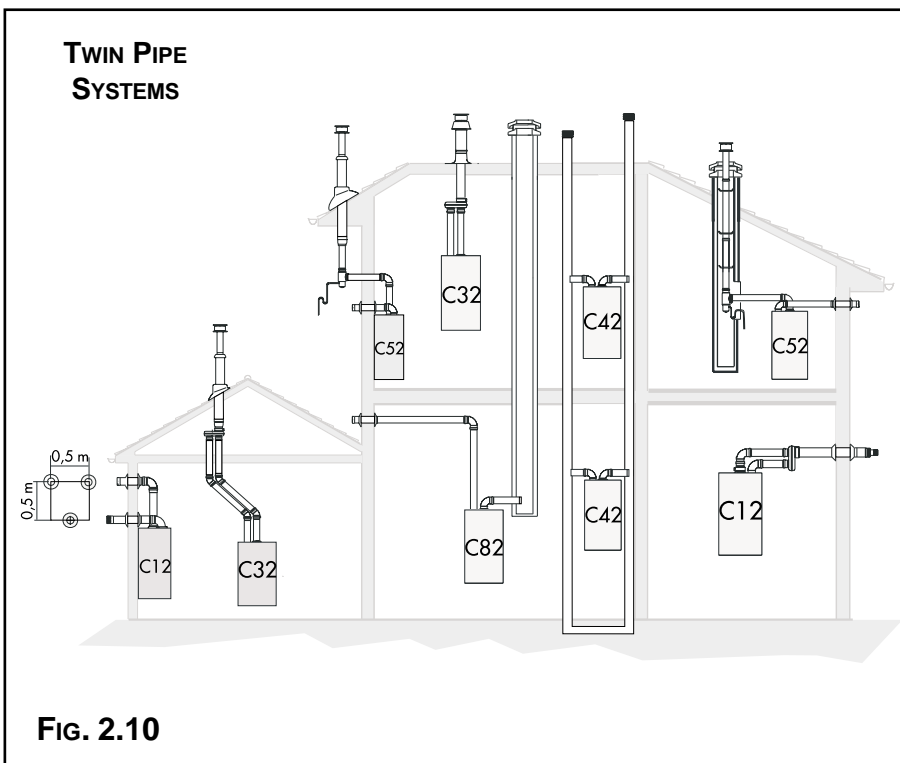

In calculating the lengths of the pipes, the maximum length "L" must also take into consideration the values for the exhaust/air intake end terminals, as well as 90° elbows for coaxial systems.

The C52 types must comply with the following requirements:

- 1 - The exhaust/ air intake pipes must have the same diameter of ø 80 mm.
- 2 - If elbows are to be inserted into the air intake and/or exhaust system, the calculation of the overall length must take into consideration the values for each elbow, see the **FLUE PIPE ACCESSORIES MANUAL**.
- 3 - The exhaust pipe must protrude by at least 0.5 m above the top of the roof in the event that it is located on the opposite side of the building to the side with the air intake (this condition is not obligatory when the air intake and exhaust are located on the same side of the building).

## 2.10 ROOM THERMOSTAT CONNECTION

To connect a room thermostat and/or time clock, it is necessary to:

1. - Open the control panel as indicated in section 4.3;
2. - Remove screws "A" and remove the inspection cover from the reverse of the control panel;
3. - For the room-thermostat connect the thermostat switching wires to the position 5 and 6 and remove the wire link (for three-wire thermostats connect the neutral to terminal N);
4. - For the time clock connect the clock switching wires to the positions 3 and 4 and connect the clock motor electrical supply to the terminals marked L and N.

**Note:** A frost thermostat is built-in to the appliance.

**For connection to control systems with zone valves for hot water cylinders see section 3.**

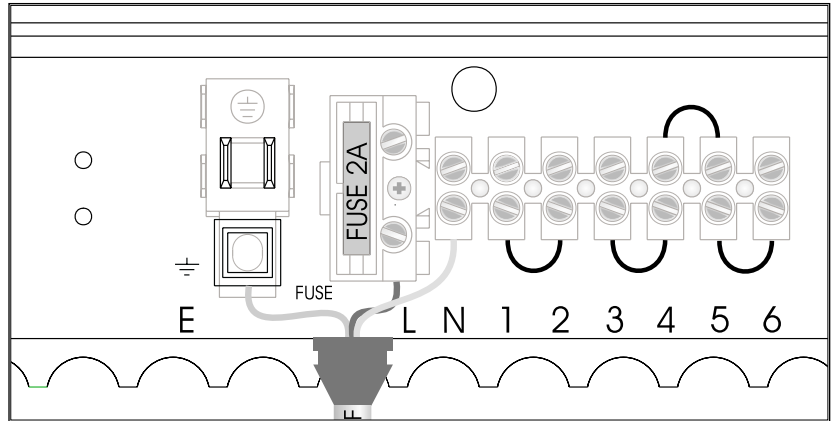
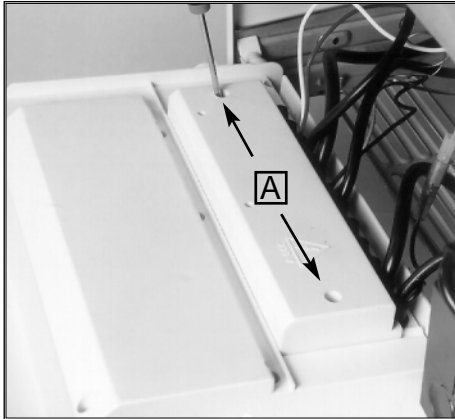

## 2.11 ELECTRICAL DIAGRAM

### LEGEND:

- A - On/Off Switch
- B - On/Off L.E.D.
- C - Heating Switch
- D - Heating L.E.D.
- E - Reset Button
- F - Ignition Failure (Lockout) L.E.D.

- A01 - Pump Pressure Switch
- A02 - Frost Thermostat
- A03 - Modulator
- A04 - Circulation Pump
- A05 - Regulation Thermostat
- A06 - External Control System
- A07 - Time Clock Connector
- A08 - External (Room) Thermostat
- A09 - Air Pressure Switch
- A10 - Fan

- A11 - Overheat Thermostat
- A12 - Spark Generator/Gas Valve Supply
- A13 - Detection Electrode

### Colours:

- Wh -White
- Bl -Blue
- Gry -Grey
- Brn -Brown
- Blk -Black
- Rd -Red
- Grn/Yll -Yellow/Green

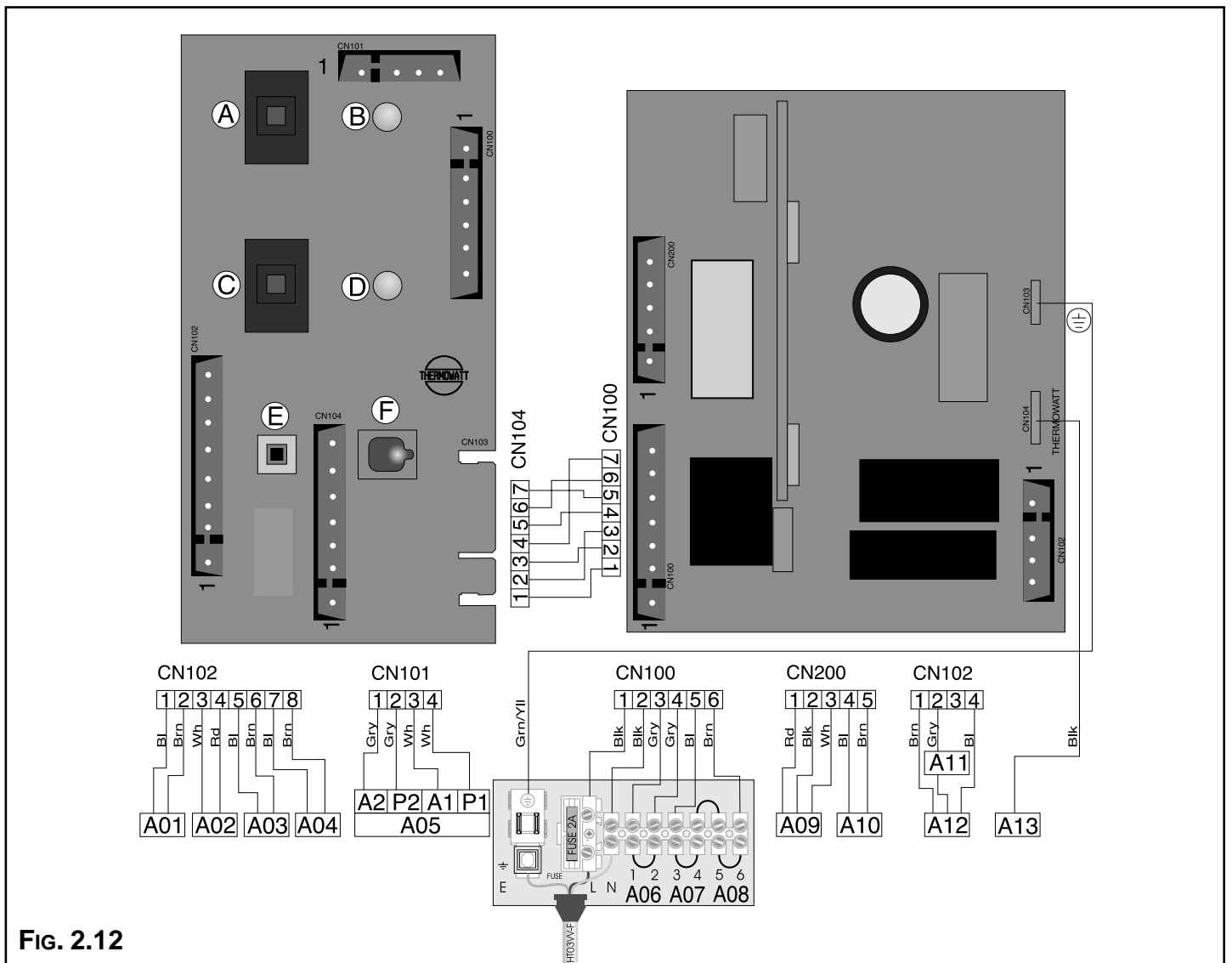
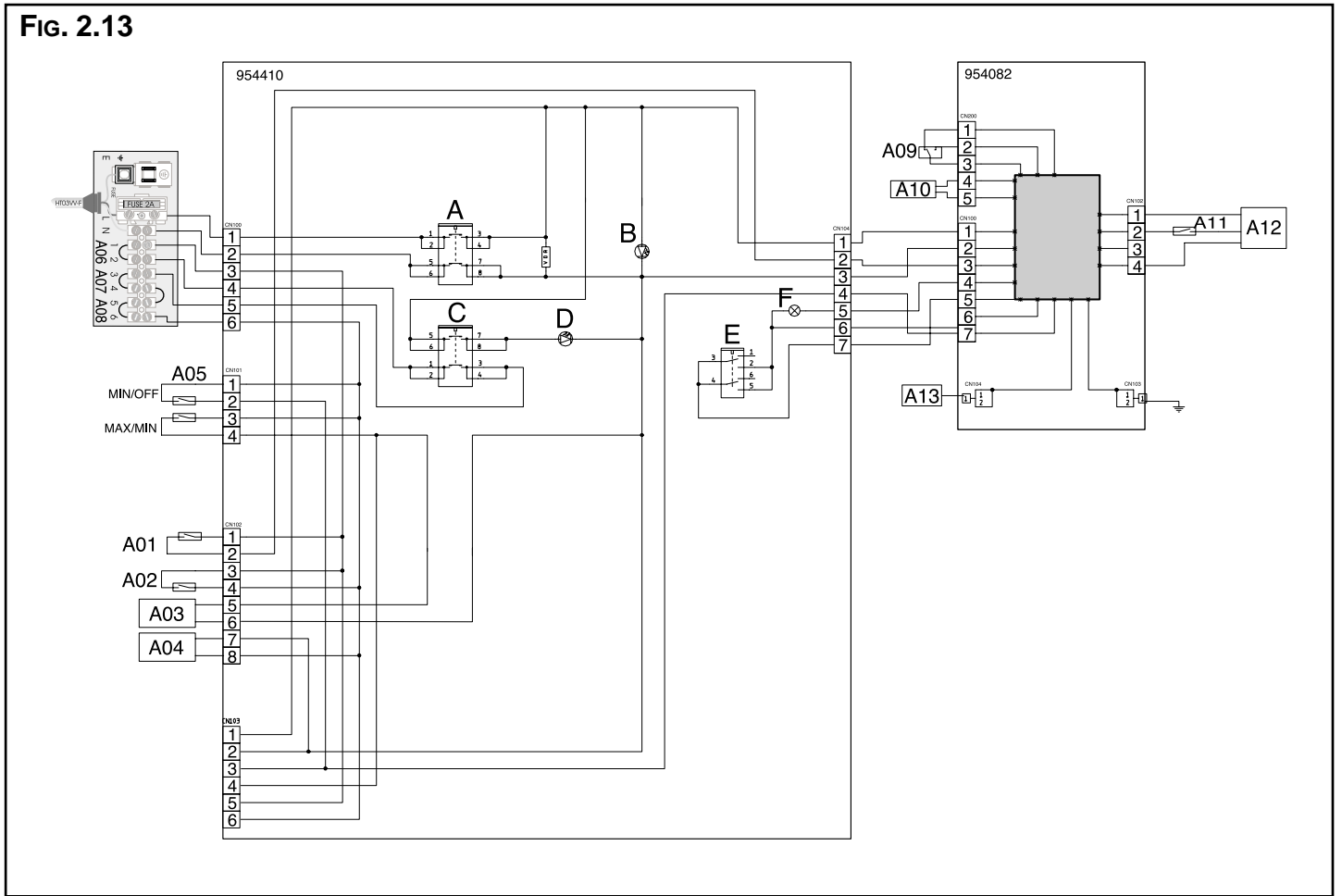

FIG. 2.12

**FIG. 2.13**



**2.12 GAS AND WATER CIRCUITS**

**FIG. 2.14**

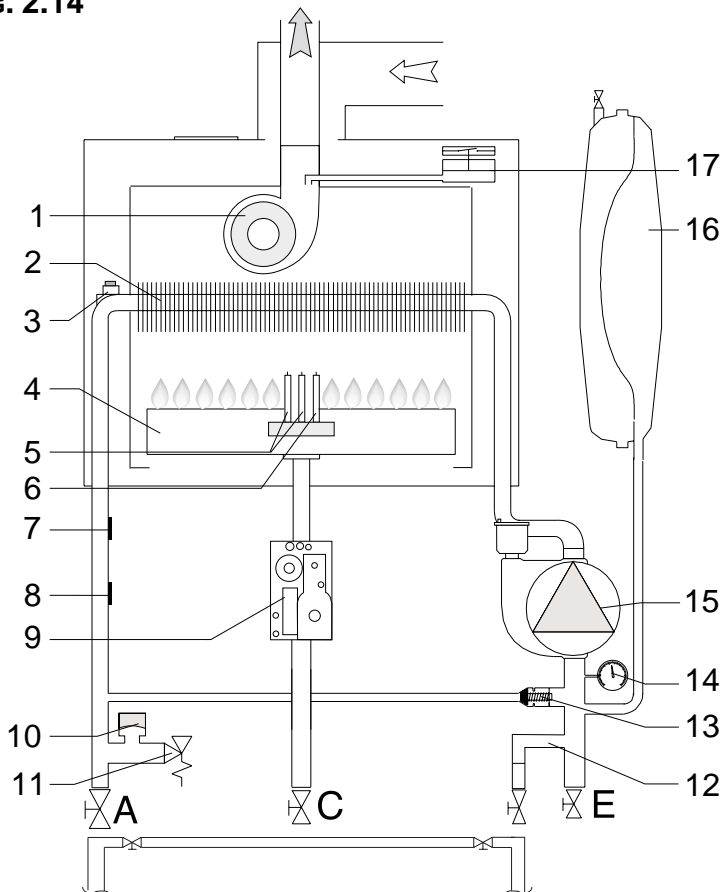

**LEGEND:**

1. Fan
  2. Main heat exchanger
  3. Overheat thermostat
  4. Burner
  5. Ignition electrodes
  6. Detection electrode
  7. Regulation thermostat
  8. Frost thermostat
  9. Gas valve
  10. Pump pressure switch
  11. Safety valve (3 bar)
  12. Boiler drain valve
  13. Automatic by-pass
  14. Pressure gauge
  15. Circulation pump with automatic air release valve
  16. Expansion vessel
  17. Air pressure switch
- A. Central Heating Flow  
 B. Inlet Gas  
 C. Central Heating Return

### 3. D.H.W. STORAGE CYLINDER

The microSYSTEM can be connected to a storage cylinder (both open-vented and unvented) for the production of domestic hot water (D.H.W.). Cylinders of different capacities can be used depending on site requirements (see TABLE 3.1 for a selection of ARISTON unvented cylinders).

#### 3.1 2 PORT AND 3 PORT VALVE INSTALLATIONS

##### 2 port valve installation

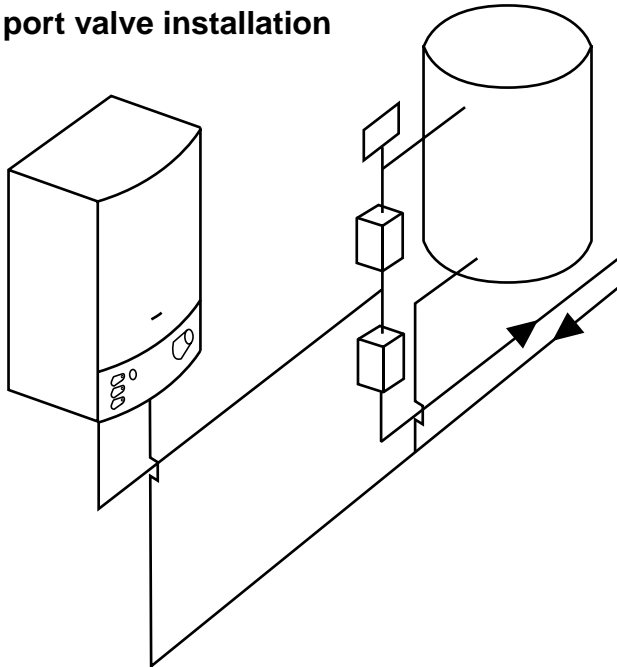

FIG. 3.1

##### 3 port valve installation

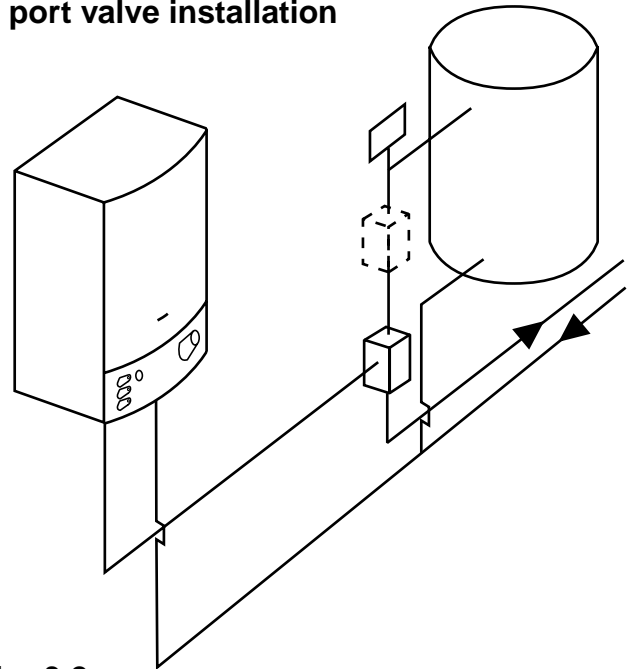
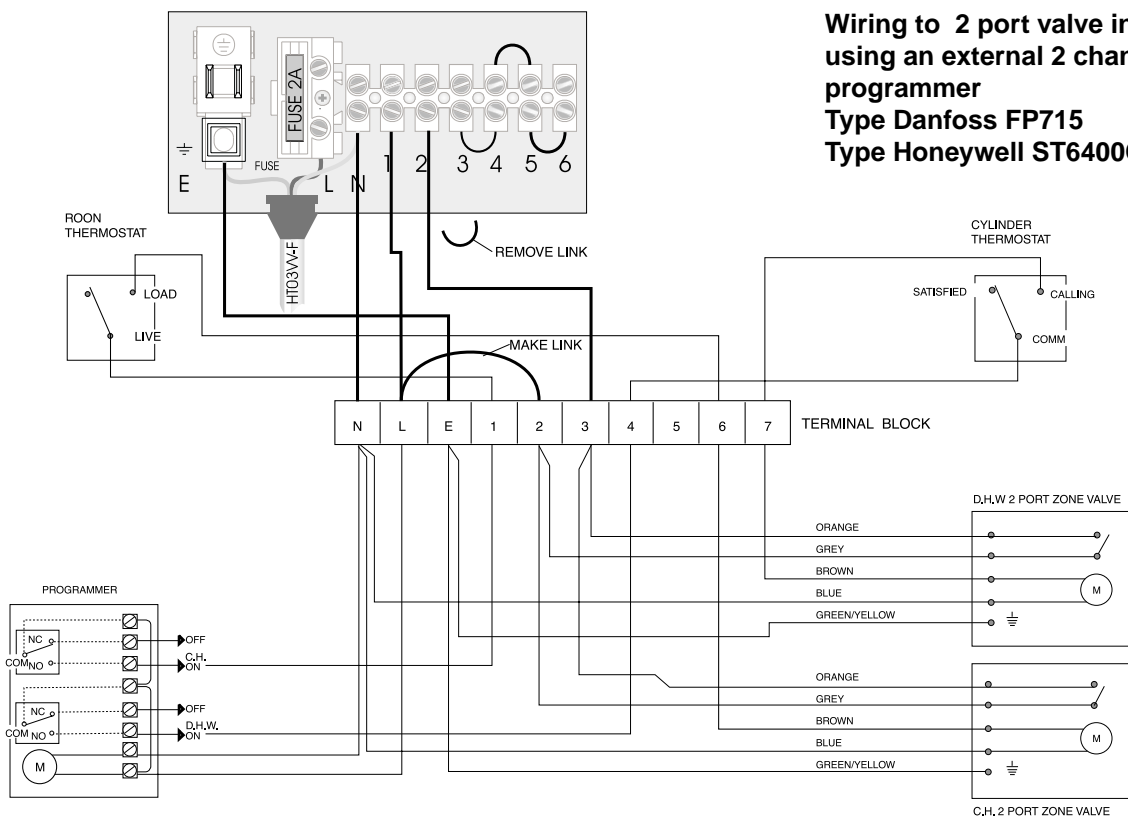
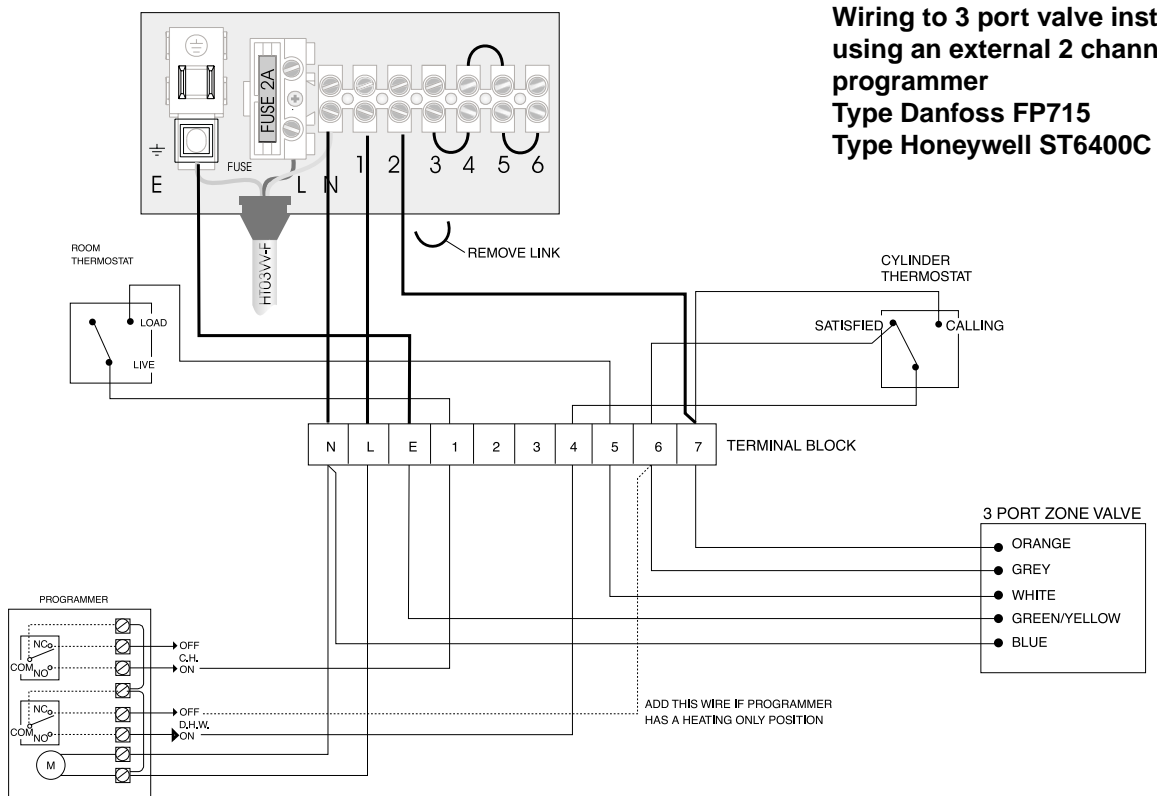

FIG. 3.2

FIG. 3.3





**FIG. 3.4**

**NOTE:** When using a 3 port valve installation in conjunction with an unvented cylinder it will be necessary to use a 2 port valve on the cylinder flow connection in addition to the 3- port valve to satisfy Building Regulations.

**TABLE 3.1**

Technical Data MODEL	Capacity lt.	Coil Surface m <sup>2</sup>	C.H.W. Flow/rate m <sup>3</sup> /h	D.H.W. Flow/rate lt/h	Max Heating Output kW	Heat loss kWh/24h
<b>Contract STI 125 Indirect</b>	125	0.75	0.5 1 2	194 266 340	11.3 15.5 19.8	2
<b>Comfort STI 125 Indirect</b> <b>Contract STI 150 Indirect</b>	125 150	0.75 0.93	0.5 1 2	256 353 451	14.9 20.5 26.2	2.2
<b>Comfort STI 150 Indirect</b> <b>Contract STI 210 indirect</b>	150 200	0.93 0.93	0.5 1 2	256 353 451	14.9 20.5 26.2	2.4
<b>Comfort STI 210 Indirect</b> <b>Contract STI 300 Indirect</b>	200 300	0.93 0.93	0.5 1 2	256 353 451	14.9 20.5 26.2	2.9
<b>SB 125 Indirect</b>	125	1	0.5 1 2	190 318 496	11 18.5 28.8	1.72
<b>SB 150 Indirect</b>	150	1	0.5 1 2	190 318 496	11 18.5 28.8	1.75
<b>SB 200 Indirect</b>	200	1.3	0.5 1 2	190 318 496	11 18.5 28.8	2.1



## 3.2 DOMESTIC HOT WATER PRIORITY KIT

Boiler Cylinder	microSYSTEM 21 RFFI	microSYSTEM 28 RFFI
Contract STI 125 Indirect	■	
Comfort STI 125 Indirect	■	
Contract STI 150 Indirect	●	■
Comfort STI 150 Indirect	●	■
Contract STI 210 Indirect	●	●
Comfort STI 210 Indirect	●	●
Contract STI 300 Indirect	■	●
SB 125 Indirect	■	
SB 150 Indirect	●	●
SB 200 Indirect	●	●

TABLE 3.2

● = Ideal  
■ = Possible

The *microSYSTEM* is able to be connected to a specially designed kit for the management of D.H.W. production. This kit gives priority to production of D.H.W. unlike traditional systems where the boiler power is split between C.H. and D.H.W. This generally enables a smaller storage cylinder to be chosen as the boiler's full output will be channelled into the cylinder allowing for a quick heat-up.

The kit (ARISTON part number 706329) can be obtained from an ARISTON supplier.

The kit consists of:

- 1) Electronic module able to plug into the boiler's P.C.B;
- 2) 3-way priority valve with actuator for connection to the boiler's flow outlet;
- 3) A limit thermostat (80°C) to check the water temperature of the heating flow to the cylinder, to be installed within the boiler;
- 4) Pipes and accessories.

## 4. COMMISSIONING

### 4.1 INITIAL PREPARATION

MTS (GB) Limited support the *benchmark* initiative. Within the information pack you will find a copy of the *benchmark* logbook. It is important that this is completed in the presence of your customer, they are shown how to use it, and it is signed by them. Please instruct your customer that they must have their *benchmark* logbook with them whenever they contact a service engineer or us.

Preliminary electrical system checks to ensure electrical safety must be carried out by a competent person i.e. polarity, earth continuity, resistance to earth and short circuit.

#### FILLING THE HEATING SYSTEM:

Remove the panels of the case and lower the control panel (see section 3.3 for further information).

Open the central heating flow and return cocks supplied with the connection kit (there are two isolation points on the return connection).

Unscrew the cap on the automatic air release valve one full turn and leave open permanently.

Close all air release valves on the central heating system.

Gradually open valve(s) at the filling point (filling-loop) connection to the central heating system until water is heard to flow, do not open fully.

Open each air release tap starting with the lowest point and close it only when clear water, free of air, is visible.

**Purge the air from the pump by unscrewing anticlockwise and removing the pump plug and also manually rotate the pump shaft in the direction indicated by the pump label to ensure the pump is free.**

Refit the pump plug.

Continue filling the system until at least 1.5 bar registers on the pressure gauge.

Inspect the system for water leaks and remedy any leaks discovered.

#### GAS SUPPLY:

Inspect the entire installation including the gas meter, test for soundness and purge the supply as described in BS 6891:1988.

Open the gas cock (supplied with the connection kit) to the appliance and check the gas connections on the appliance for leaks.

When the installation and filling are completed turn on the central heating system (section 4.4) and run it until the temperature has reached the boiler operating temperature. The system must then be immediately flushed through.

The flushing procedure must be in line with BS 7593:1992 code of practice for treatment of water in domestic hot water central heating systems.

During this operation, we highly recommend the use of a central heating flushing detergent (Ferox Superfloc or equivalent), whose function is to dissolve any foreign matter that may be in the system.

**Substances different from these could create serious problems to the pump or other components.**

The use of an inhibitor in the system such as Ferox MB-1 or equivalent is strongly recommended to prevent corrosion (*sludge*) damaging the boiler and system.

**Failure to carry out this procedure may invalidate the appliance warranty.**

## 4.2 CONTROL PANEL

LEGEND:

- A - On/Off button
- B - On/Off L.E.D. green (frost protection active)
- C - Central Heating button
- D - Central Heating active L.E.D. green
- E - Ignition failure (lockout) and/or overheat reset button
- F - Ignition failure (lockout) and/or overheat L.E.D. red
- G - Central heating temperature adjustment
- H - Energy Saving System (ESS)
- I - Knock-out for time clock
- J - Heating system pressure gauge

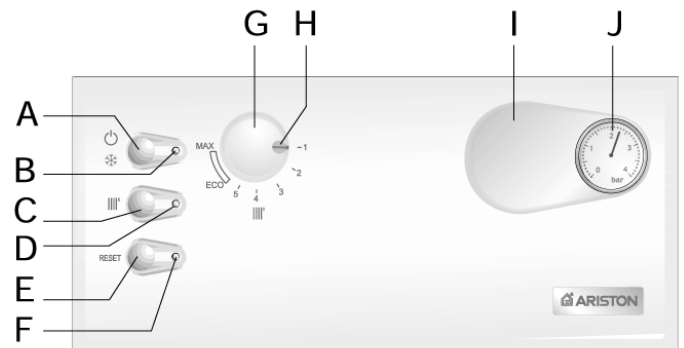
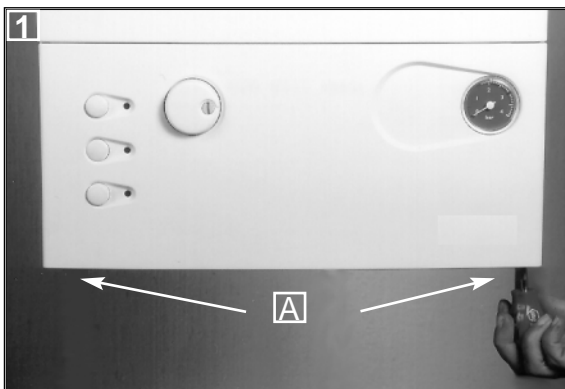

Fig. 4.1

## 4.3 REMOVING THE FRONT PANEL



In order to access the inside of the boiler, it is necessary to unscrew the fastening screws "A" of the control panel located on the lower part of the panel itself.

The control panel moves downward and when pulled forward rotates on two lateral hinges.

The panel stays in a semi-horizontal position, which allows access to the inner parts of the boiler.

In order to increase the manoeuvring space, it is possible to raise the control panel and rotate it to a fully horizontal position.

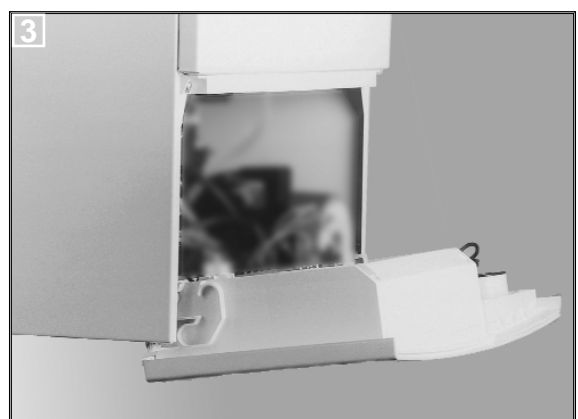

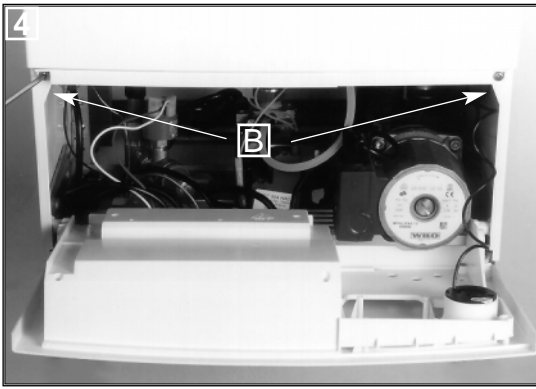

To dismantle the front casing panel it is necessary to:

- 1 - Remove the two screws "B";
- 2 - Move the front casing panel up and lift forward.



#### 4.4 INITIAL START-UP

*THE CHECKS TO BE RUN BEFORE INITIAL START-UP ARE AS FOLLOWS:*

1. Make sure that:
  - the screw on the automatic air valve has been loosened when the system is full;
  - If the water pressure in the system is below 1.5 bar, bring it up to the appropriate level;
  - Ensure that the gas cock is closed;
  - Make sure that the electrical connection has been made properly and that the earth wire is connected to an efficient earthing system;
  - Supply power to the boiler by pushing the On/Off button "A" (see Fig.4.1) - the L.E.D. "B" will illuminate. Then push the button "C" in for central heating - the L.E.D. "D" will illuminate. This will start the circulation pump. After 7 seconds, the boiler will signal a shutdown due to ignition failure. Leave the boiler as it is until all of the air has been bled from the system.
  - Loosen the cap on the head of the pump to eliminate any air pockets;
  - Repeat the procedure for bleeding the radiators of air;
  - Check the system pressure and, if it has dropped, open the filling loop again to bring the pressure back up to 1.5 bar.
2. Make sure that all gate valves are open;
3. Turn on the gas cock and check the seals on the connections with an approved soap solution and eliminate any leaks.
4. Press the reset button "E" for the lighting system; the spark will light the main burner. If the burner does not light the first time, repeat the procedure.
5. Check the minimum and maximum pressure values for the gas going to the burner; adjust it if needed using the values indicated in the table in section 5 (See the relative section for burner pressure adjustment within the servicing manual).

#### 4.5 COMBUSTION ANALYSIS

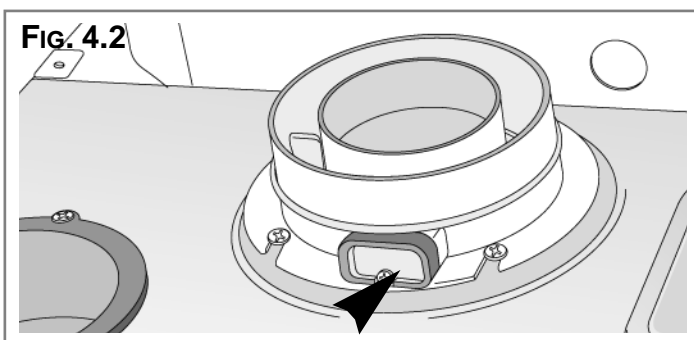

The flue connector has two apertures, readings can be taken for the temperature of the combustion by-products and of the combustion air, as well as of the concentrations of O<sub>2</sub> and CO<sub>2</sub>, etc. .

To access these intakes it is necessary to unscrew the front screw and remove the metal plate with sealing gasket. To achieve the best test conditions, turn the central heating adjustment knob "G" to the "max" position and remove the electrical connection to the heating sensor (see section 6.). This will allow the appliance to operate at the maximum heating power.

## 4.6 FUME DISCHARGE MONITORING

In the boiler, it is possible to monitor the correct operation of the flue exhaust/air intake, checking for a loss of general pressure in the system. Through the use of a differential manometer connected to the test points of the combustion chamber, it is possible to detect the  $\Delta P$  of operation of the air pressure switch.

The value detected should not be less than 0.55 mbar under conditions of maximum thermal power in order for the boiler to function properly and without interruption.

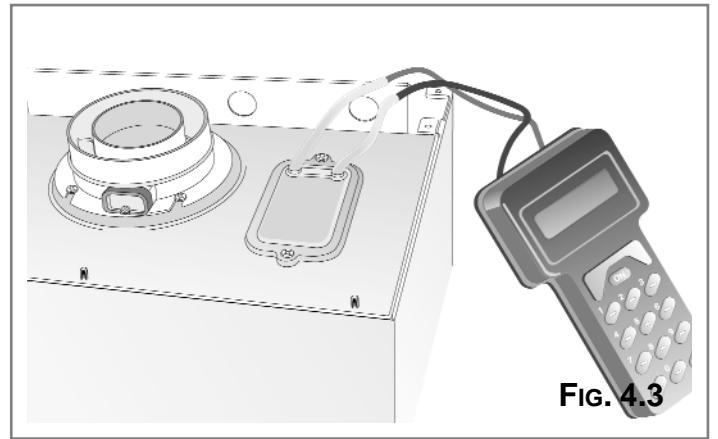

## 4.7 BOILER SAFETY SYSTEMS

The boiler is fitted with the following devices (see section 4.2 for references).

1 - *IGNITION FAILURE:*

This indicates ignition failure when a flame is not detected within 7 seconds of starting an ignition sequence. The L.E.D. "F" will illuminate to signal the shutdown status.

The system can be reset by pressing and releasing the button "E" after checking to make sure that the gas cock is open.

2 - *INSUFFICIENT SYSTEM PRESSURE:*

In the event of insufficient water pressure in the heating system, a safety device will shutdown the boiler. Check the system pressure on the pressure gauge "J" and if it is less than 0.4 bar refill the system to 1.5 bar. Once the system pressure is at the correct level the boiler will ignite automatically.

3 - *OVERHEATING:*

This control shuts off the boiler in the case where the primary circuit reaches a temperature in excess of 105°C.

The red L.E.D. "F" will illuminate to signal this shutdown status.

The system can be reset by waiting a few minutes for the primary exchanger to cool down and then by pressing and releasing the "E" button.

4. *ANTI-FROST DEVICE:*

The boiler is equipped with a device that, in the event of the water temperature going below 6°C, the burner ignites at the minimum power until the boiler water reaches a temperature of 16°C.

This device operates only if the boiler is functioning perfectly and:

- the system pressure is sufficient;
- the boiler is powered electrically - L.E.D. "B" illuminated;
- the gas is turned on.

5 - *EXHAUST DISCHARGE ANOMALY SHUTDOWN:*

The boiler is fitted with safety devices, which in the event of defective discharge of exhaust fumes, automatically interrupts the gas supply, thereby shutting off the boiler.

The shutdown of the boiler is temporary and when the discharge state of exhaust fumes has returned to normal, the boiler automatically turns back on

## 4.8 DRAINING THE SYSTEM

The heating system must be emptied as follows:

- Turn off the boiler;
- Attach a hose pipe and open the drain valve;
- Empty the system at the lowest points (where present). When the heating system is unused for an extended period of time, it is recommended that you add antifreeze with an ethylene glycol base to the water in the heating lines and radiators if the ambient temperature drops below 0°C during the winter.

This makes repeated draining of the entire system unnecessary.

CATEGORY I12H3+		Methane Gas G20	Liquid Butane Gas G30	Liquid Propane Gas G31
Lower Wobbe Index (15°C;1013mbar)	MJ/m³h	45.67	80.58	80.58
Nominal Delivery Pressure	mbar	20	29	37
Minimum Delivery Pressure	mbar	17	20	25
<b>21 RFFI</b>				
Main Burner: n. 12 jets (∅)	mm	1.30	0.77	0.77
Consumption (15°C; 1013mbar)	m³/h	2.4 - 1.05	----	----
Consumption (15°C; 1013mbar)	Kg/h	----	1.78 - 0.78	1.76 - 0.77
Gas Burner Pressure: max - min	mbar	8.5 - 1.7	27.5 - 6.2	37.4 - 8.0
<b>28 RFFI</b>				
Main Burner: n. 14 jets (∅)		1.30	0.77	0.77
Consumption (15°C; 1013mbar)	m³/h	3.15 - 1.26	----	----
Consumption (15°C; 1013mbar)	Kg/h	----	1.78 - 0.78	1.76 - 0.77
Gas Burner Pressure: max - min	mbar	11.0 - 1.6	27.7 - 4.6	35.5 - 6.0

[1 mbar = 10,197 mmc.a.]

The outlet pressure of the gas cock is obtained by completely loosening the screw on the solenoid. The maximum pressure of the gas to the burner will be equal to the nominal delivery pressure minus the head loss within the gas valve.

5.1 CHANGING THE TYPE OF GAS

**The boiler can be converted to use either methane (natural) gas (G20) or LPG (G30 - G31) by an Authorised Service Centre.**

The operations that must be performed are the following:

1. Replace the jets on the main burner (see table in section 5);
2. Adjust the maximum and minimum thermal capacity values for the boiler (see table in section 5);
3. Replace the gas rating plate;
4. Adjust the maximum thermal power setting;
5. Adjust the soft-light feature (open the cover of the regulation screw on the gas valve (see Fig. 5.1). Rotate clockwise from min. to max. as per installation requirements).

Fig. 5.1

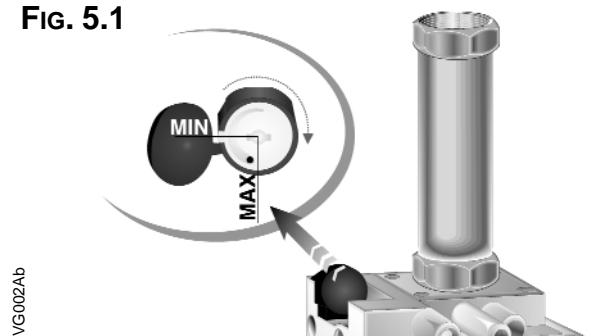

VG002Ab

## 6. MAINTENANCE

*It is recommended that the following inspections be carried out on the boiler at least once a year:*

- 1 - Check the seals for the water connections; replace any faulty seals.
- 2 - Check the gas seals; replace any faulty gas seals.
- 3 - Visual check of the entire unit.
- 4 - Visual check of the combustion process or analysis of combustion by-products (see section 4.5) and cleaning of the burner if needed.
- 5 - If called for by point. 3, dismantling and cleaning of the combustion chamber.
- 6 - If called for by point. 4, dismantling and cleaning of the burner jets.
- 7 - Visual check of the primary heat exchanger:
  - check for overheating in the blade assembly;
  - clean the exhaust fan if needed.
- 8 - Adjustment of the flow rate of the gas: flow rate for lighting, partial load and full load.
- 9 - Check of the heating safety systems:
  - safety device for maximum temperature (overheat thermostat);
  - safety device for maximum pressure (safety valve).
- 10- Check of the gas safety systems:
  - safety device for lack of gas or flame ionisation (detection electrode);
  - safety device for gas cock.
- 11- Check of the electrical connection (make sure it complies with the instructions in the manual).
- 12- General check of the combustion by-products of the discharge/ventilation system.
- 13- Check of the general performance of the unit.



## 6. TECHNICAL INFORMATION

		<b>microSYSTEM</b> 21 RFFI	<b>microSYSTEM</b> 28 RFFI
CE Certification		63AU4549	63AU4549
Heat Input	max/min kW	22.7/10.0	29.8/12.0
Heat Output	max/min kW	21.0/8.7	27.8/10.5
Efficiency of Nominal Heat Input	%	92.8	93.5
Efficiency at 30% of Nominal Heat Input	%	90.8	90.7
Heat Loss to the Casing ( $\Delta T=50^{\circ}\text{C}$ )	%	1.2	0.2
Flue Heat Loss with Burner Operating	%	6.0	6.3
Flue Heat Loss with Burner Off	%	0.2	0.4
Maximum Discharge of Fumes (G20)	Kg/h	46.2	60
Residual Discharge Head	mbar	0.70	1.60
Consumption at Nominal Capacity(G20)	m <sup>3</sup> /h	2.4	3.15
Gas Consumption after 10 Minutes* (15°C, 1013 mbar) (G30-G31)	m <sup>3</sup> Kg/h	0.32/0.39 1.78/1.76	0.37 2.34/2.31
Temp. of exhaust fumes at nominal capacity	°C	117.2	128.8
CO <sub>2</sub> Content	%	6.81	6.9
O <sub>2</sub> Content	%	9	8.1
CO Content	ppm	20	48
Minimum Ambient Temperature	°C	+5	+5
Head Loss on Water Side (max) ( $\Delta T=20^{\circ}\text{C}$ )	mbar	200	200
Residual Head of System	bar	0.25	0.25
Heating Temperature	max/min °C	82/42	82/42
Expansion Vessel Capacity	l	6	6
Expansion Vessel Pre-load Pressure	bar	1	1
Maximum Water Content of System	l	130	130
Maximum Heating Pressure	bar	3	3
Nominal Pressure	Natural Gas (G20) mbar LPG (G30-G31) mbar	20 30-37	20 30-37
Electrical Supply	V/Hz	230/50	230/50
Power Consumption	W	155	155
Protection Grade of Electrical System	IP	X4D	X4D
Internal Fuse Rating		FAST 2 AT	FAST 2 AT
Weight	Kg	39	39
<b>G.C. Number</b>		<b>41-116-06</b>	<b>41-116-07</b>

\*Calculated at 70% maximum output

Manufacturer: **Merloni TermoSanitari SpA - Italy**

Commercial subsidiary: **MTS (GB) LIMITED**

MTS Building

Hughenden Avenue

High Wycombe

Bucks HP13 5FT

Telephone: (01494) 755600

Fax: (01494) 459775

Internet: <http://www.mtsgb.ltd.uk>

E-mail: [info@mtsgb.ltd.uk](mailto:info@mtsgb.ltd.uk)

**Technical Service Hot Line: (01494) 539579**



# micro **SYSTEM**

## Servicing Instructions

### Type C Boilers

G.C.N: 41-116-06

41-116-07

LEAVE THESE INSTRUCTIONS  
WITH THE END-USER



*The code of practice for the installation,  
commissioning & servicing of central heating systems*

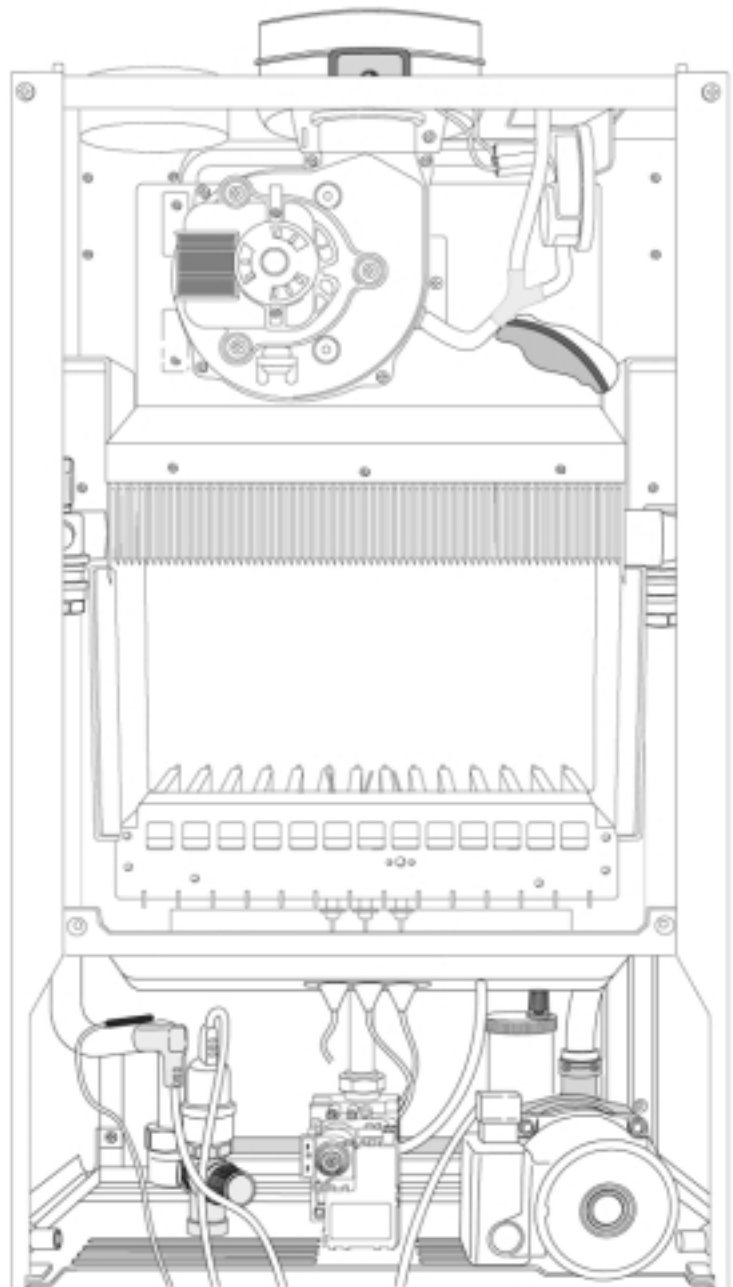

 **ARISTON**

# **TABLE OF CONTENTS**

1. **SERVICING INSTRUCTIONS**
  - 1.1 REPLACEMENT OF PARTS
  - 1.2 TO GAIN GENERAL ACCESS
    - *Removing the front panel*
    - *Removing the sealed chamber front cover*
    - *Removing the side panels*
  - 1.3 ACCESS TO THE COMBUSTION CHAMBER
    - *Removing the combustion cover*
    - *Removing the burner and jets*
    - *Removing the electrodes*
    - *Removing the main heat exchanger*
    - *Removing the air pressure switch*
    - *Removing the fan*
  - 1.4 SERVICING AND REMOVAL OF THE GAS VALVE
    - *Setting the gas pressures*
    - *Removing the spark generator*
    - *Removing the gas valve*
  - 1.5 ACCESS TO THE WATER CIRCUIT
    - *Removing the pump pressure switch*
    - *Removing the safety valve*
    - *Removing the automatic air vent*
    - *Removing the pump*
    - *Removing the pressure gauge*
    - *Removing the expansion vessel*
    - *Removing the overheat thermostat*
    - *Removing the frost thermostat*
    - *Removing the regulation thermostat*
  - 1.6 ACCESS TO THE CONTROL SYSTEM
    - *Checking the fuses*
    - *Removing the P.C.B.s*
2. **FAULT FINDING**
  - 2.1 FAULT FINDING GUIDE (FLOW-CHARTS)
3. **ELECTRICAL DIAGRAMS**
4. **SHORT SPARE PARTS LIST**

# 1. SERVICING INSTRUCTIONS

To ensure efficient safe operation, it is recommended that the boiler is serviced annually by a competent person.

**Before starting any servicing work, ensure both the gas and electrical supplies to the boiler are isolated and the boiler is cool.**

Before and after servicing, a combustion analysis should be made via the flue sampling point (please refer to the Installation Manual for further details).

After servicing, preliminary electrical system checks must be carried out to ensure electrical safety (i.e. polarity, earth continuity, resistance to earth and short circuit).

## 1.1 REPLACEMENT OF PARTS

The life of individual components varies and they will need servicing or replacing as and when faults develop.

The fault finding sequence chart in chapter 2 will help to locate which component is the cause of any malfunction, and instructions for removal, inspection and replacement of the individual parts are given in the following pages.

## 1.2 TO GAIN GENERAL ACCESS

All testing and maintenance operations on the boiler require the control panel to be lowered. This will also require the removal of the casing.

### 1.2.1 Removing the front panel

1. Loosen the fastening screws "A" of the control panel located on the lower part of the panel itself. (FIG. 1.1);

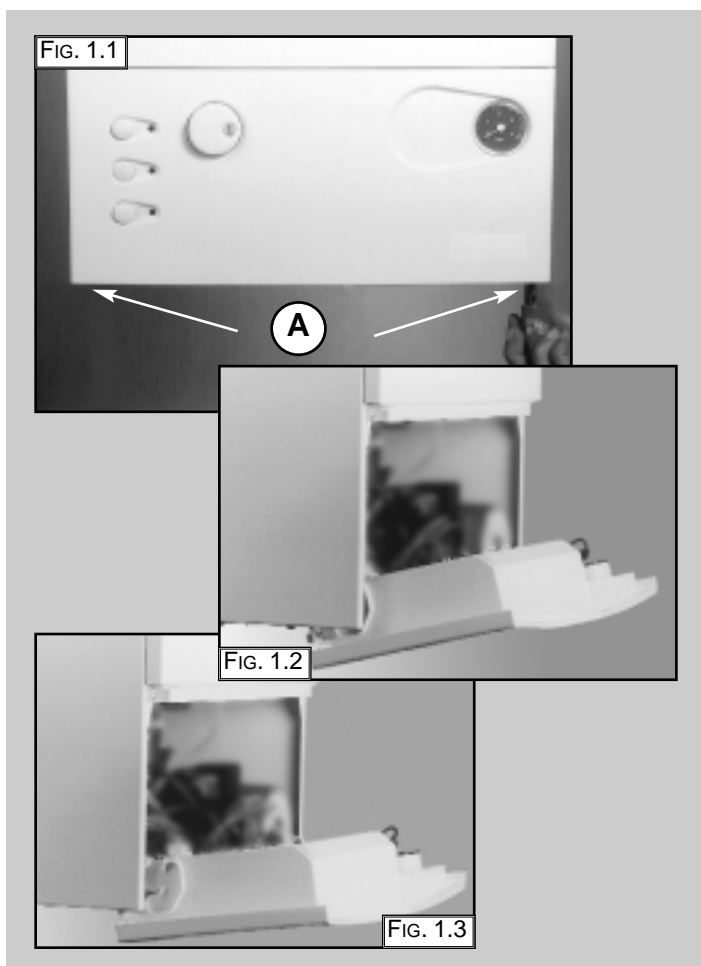

2. The control panel moves downward and when pulled forward, rotates on two lateral hinges; the panel stays in a semi-horizontal position, which allows access to the inner parts of the boiler (FIG. 1.2);
3. In order to increase the manouvering space, it is possible to raise the control panel and rotate it to a fully horizontal position (FIG. 1.3);
4. Remove the screws "B" from the front panel bottom lip (FIG. 1.4);
5. Lift the front panel up and forward from the raised screws at the the top of the casing (FIG. 1.5).

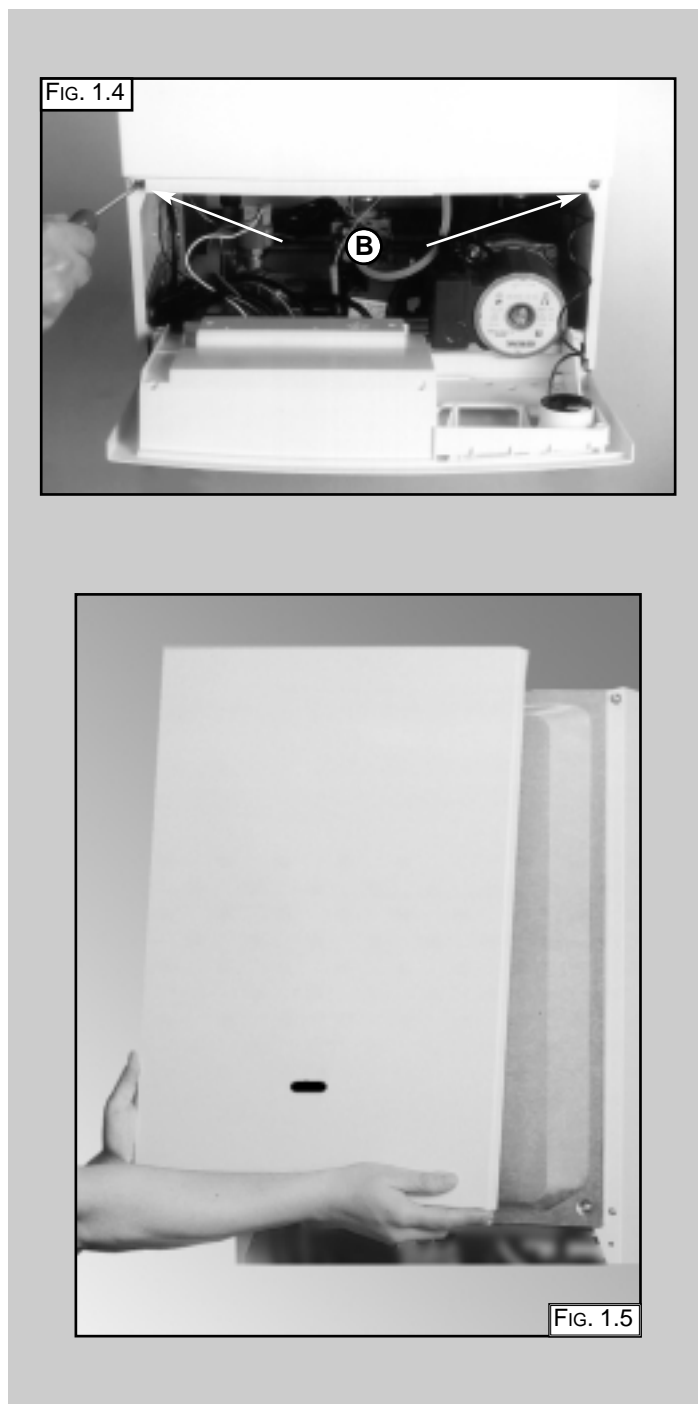

### 1.2.2 Removing the sealed chamber front cover

1. Remove the screws "C" (FIG. 1.6);
2. Lift the sealed chamber front cover from the locating pins (FIG. 1.7).

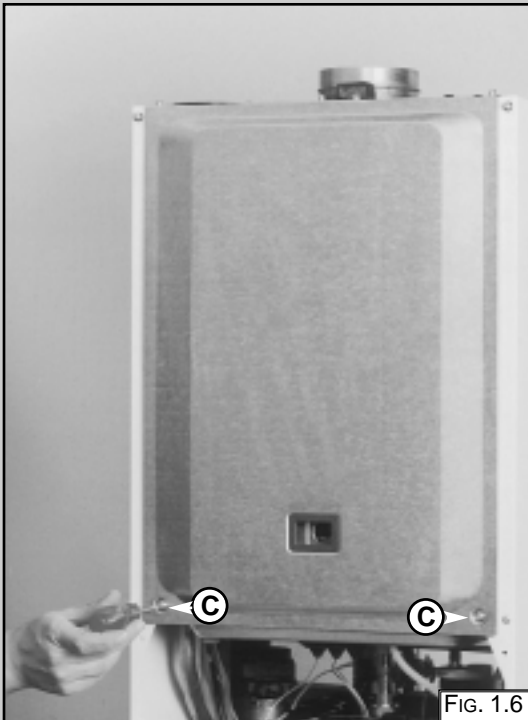

### 1.2.3 Removing the side panels

1. Remove the four screws "D" for each side panel (FIG.1.8);
2. Pull the panel away from the boiler at the base, then lift the panel up and remove from the boiler.

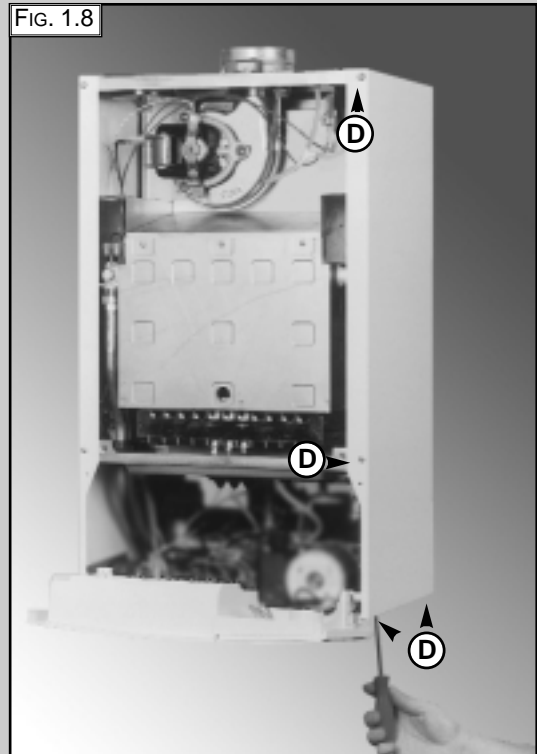

## 1.3 ACCESS TO THE COMBUSTION CHAMBER

### 1.3.1 Removing the combustion cover

1. Remove the screws "E" (FIG. 1.9);
2. Lift off the combustion cover.

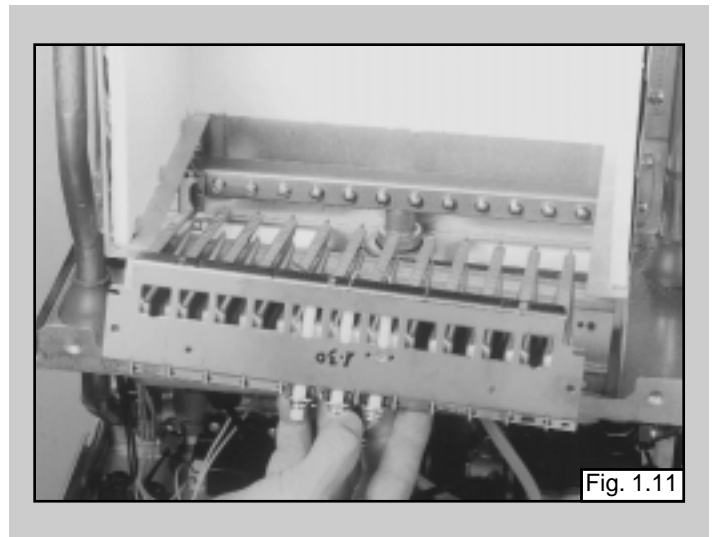
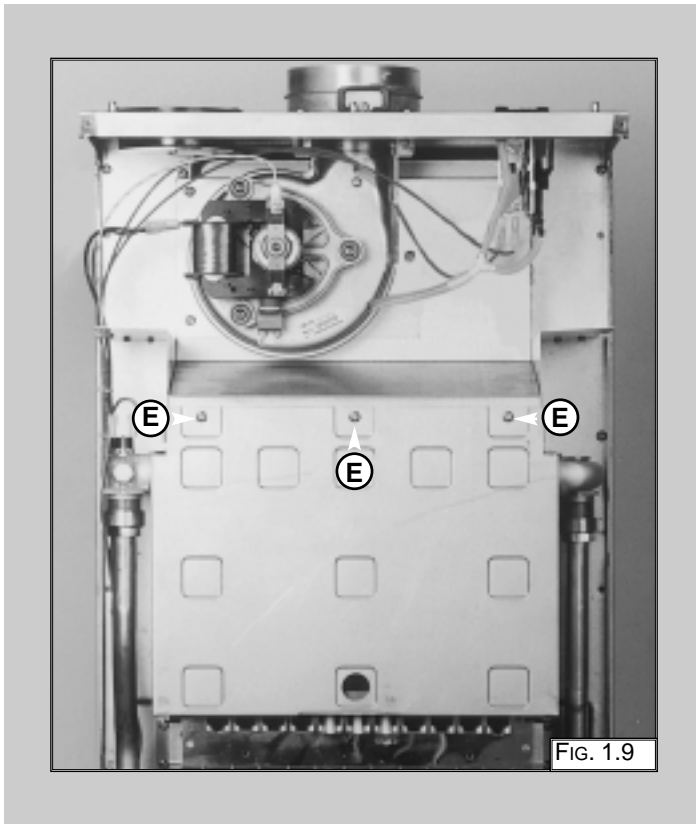

### 1.3.3 Removing the electrodes

Before carrying out this procedure, unscrew and slide the burner forward (see previous section).

1. Remove rubber gasket "G" (FIG. 1.12);
2. To remove the detection electrode disconnect the cable at its connection point close to the P.C.B. (FIG. 1.13);

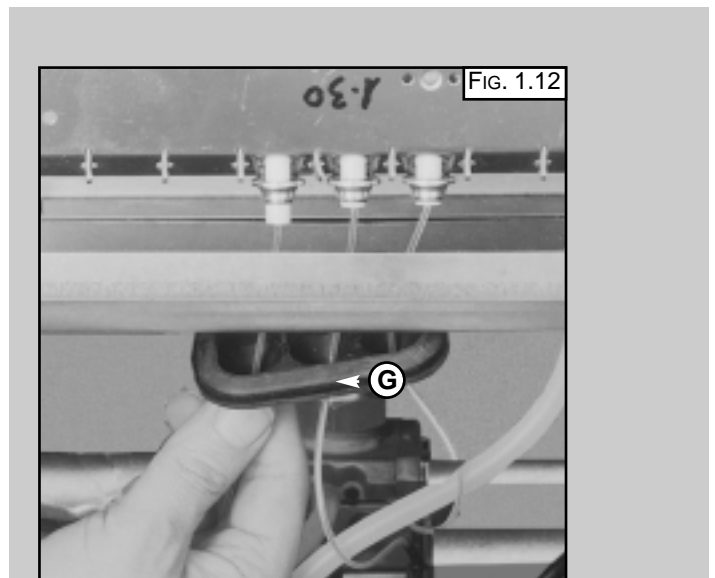

### 1.3.2 Removing the burner and jets

1. Remove the screws "F" from the burner (FIG. 1.10);
2. Remove the burner (FIG. 1.11);
3. Disconnect the electrodes (see section 1.3.3);
4. Remove the jets using a No. 7 socket spanner;
5. Replace in reverse order.

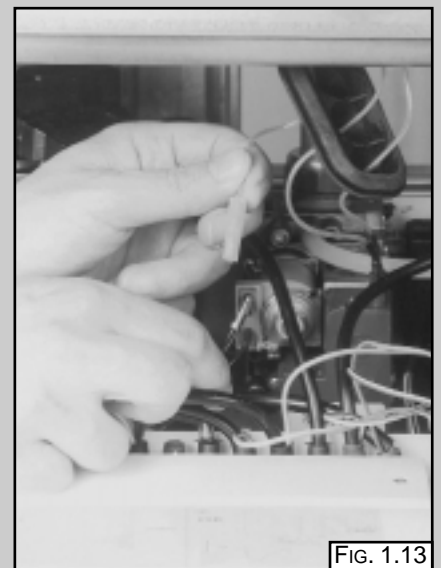
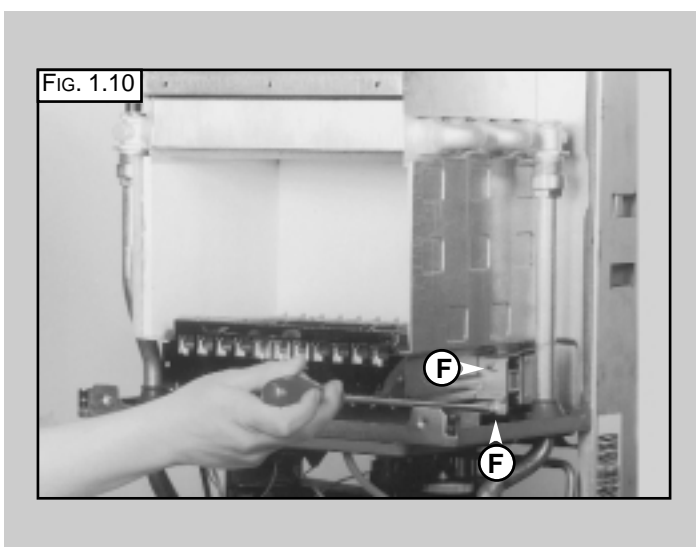

3. Remove screw "H" (FIG. 1.14);
4. Gently slide the electrode downward (FIG. 1.15).

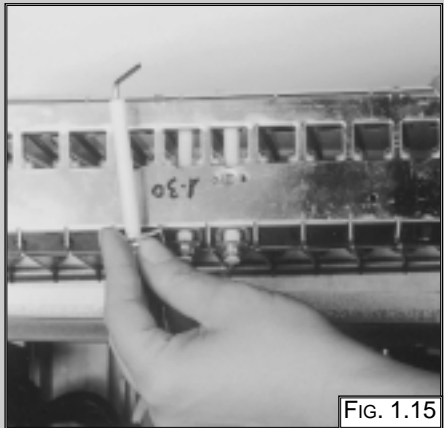
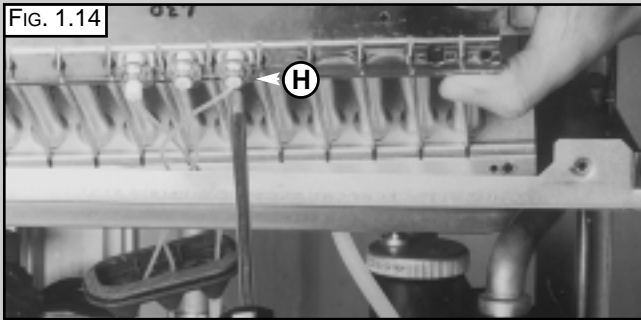

To replace, repeat the steps in reverse order, paying particular attention to the following:

- a** - Centre the electrode in the positioning hole carefully, otherwise the electrode may break;
- b** - Ensure that the left hand and right hand electrodes are located the correct way round (facing each other), to give the correct spark gap;
- c** - Check that the cables have been connected correctly;
- d** - Check that the rubber gasket covers the cable/ electrode connection point completely.

### 1.3.4 Removing the main heat exchanger

1. Drain the boiler of water;
2. Release the overheat thermostat sensor "I" (FIG. 1.16);
3. Release the two connection nuts "J" connecting the exchanger to the flow and return pipes (FIG. 1.17);
4. Remove the heat exchanger by sliding forward (FIG. 1.18).

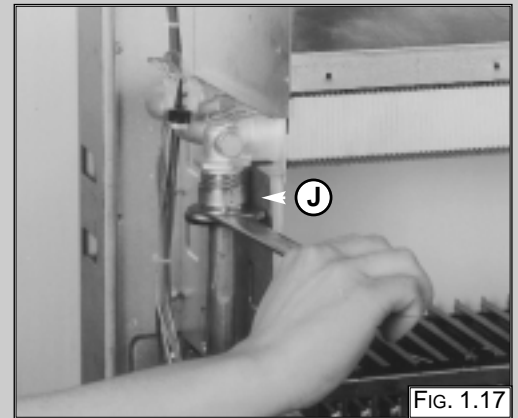
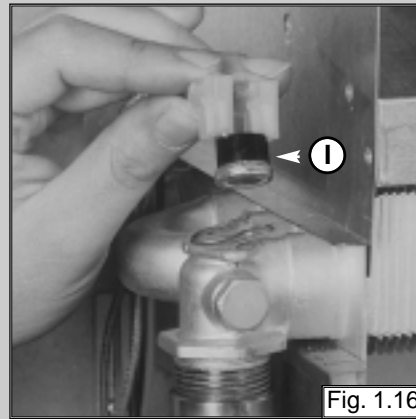

### 1.3.5 Removing the air pressure switch

1. Disconnect the electrical connections "K" and silicone pipes "L" from their connection points (FIG. 1.19);
2. Remove screws "M" on the top of the sealed chamber (FIG. 1.20);
3. Lift out the air pressure switch (FIG. 1.21);
4. Unscrew to remove the switch from the plate.

FIG. 1.19

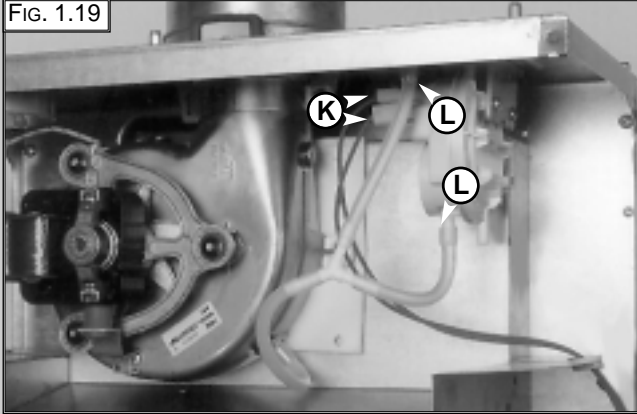

FIG. 1.20

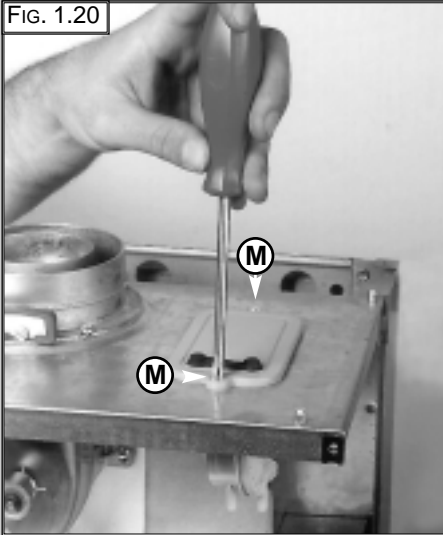

FIG. 1.21

### 1.3.6 Removing the fan

1. Disconnect electrical connections "N" and silicon pipe "O" (FIG.1.22);
2. Remove screw "P" and remove the fan collar clamp "Q" (FIG.1.23);
3. Remove screws "R" (FIG.1.24);
4. Remove fan and mounting plate (FIG.1.25).

FIG. 1.22

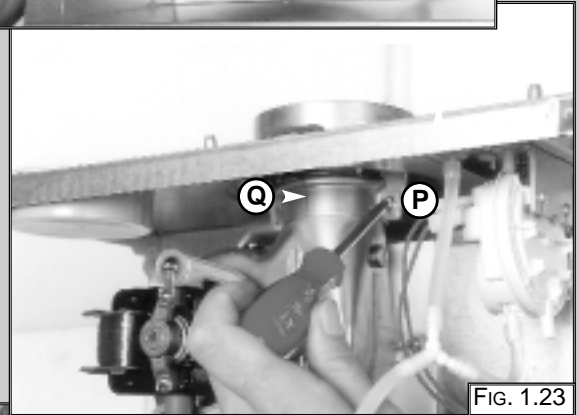
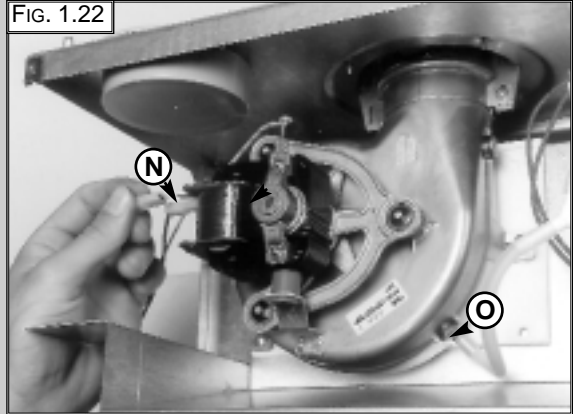

FIG. 1.23

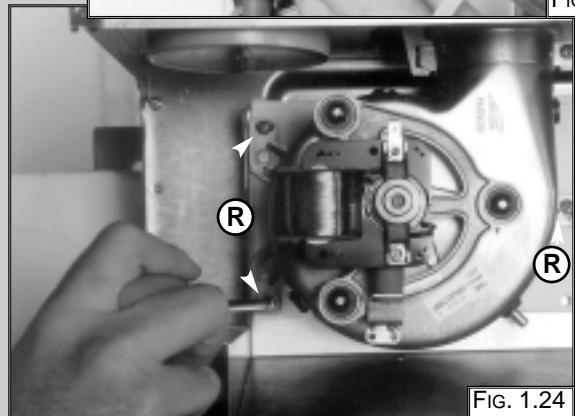

FIG. 1.24

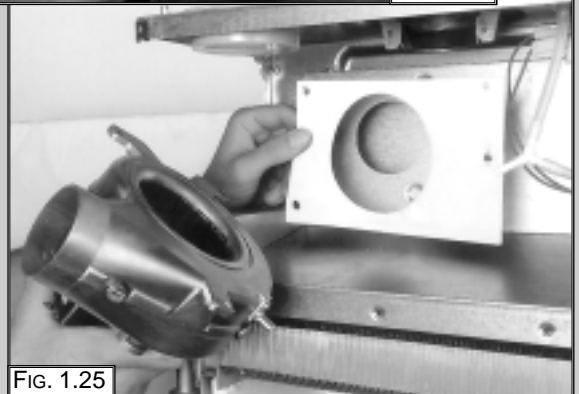
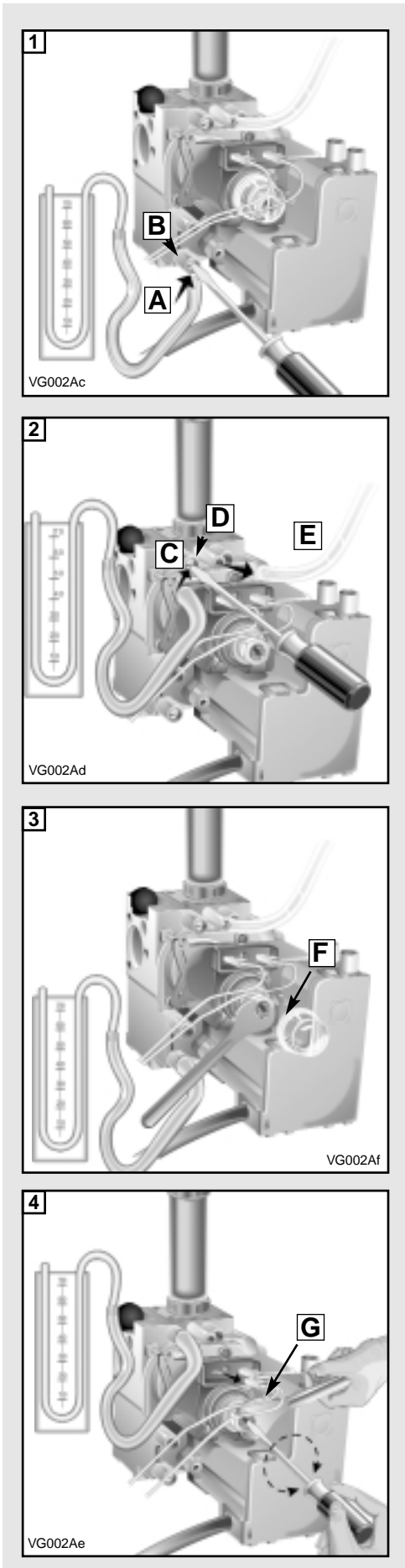

FIG. 1.25

## 1.4 SERVICING AND REMOVAL OF THE GAS VALVE

### 1.4.1 Setting the gas pressures



#### Setting the minimum and the maximum power of the boiler

1. Check that the supply pressure to the gas valve is a minimum of 20 mbar for natural gas. **Turn off the gas supply at the isolation point under the boiler**
2. To do this, slacken the screw "A".  
Fit the pipe of the pressure gauge to the inlet pressure test point of the gas valve "B".  
**Turn on the gas supply at the isolation point under the boiler and with the boiler running, read the inlet working pressure on the gauge.**  
When you have completed this operation, **turn off the gas supply at the isolation point under the boiler**, remove the pressure gauge and tighten the screw "A" securely into its housing to seal off the gas. **Turn on the gas supply at the isolation point under the boiler and test the screw for gas escaping with an approved soap and water solution.**
3. To check the pressure supplied by the gas valve to the burner, with the boiler turned off, slacken the screw "C". Fit the pipe of the pressure gauge to the outlet pressure test point of the gas valve "D".  
Disconnect the compensation pipe "E" either from the gas valve or from the sealed chamber.
4. Push the On/Off button to "ON" position -*green light*- and push the Heating button to "ON" position -*green light*-  
Turn on the boiler by setting the external controls.  
Adjust the 10mm nut "F" on the modereg to set the gas pressure Turn the nut clockwise to increase and anti clockwise to decrease the pressure until the required pressure is achieved (see **TABLE A** page 9)
5. To set the minimum power, disconnect the supply cable from the modereg and adjust screw "G" whilst holding nut "F".  
Turn the screw clockwise to increase the pressure and anticlockwise to decrease the pressure until the required pressure is achieved (see **TABLE A** page 9)
6. When you have completed the above operations, turn off the external controls, re-connect the supply terminal to the modereg on the gas valve and replace the cap on the screw of the modereg.

#### Setting pressure for soft ignition.

The soft light pressure is factory set.

If the ignition is not regular (e.g: not complete burner ignition or ignition noise) check the soft light regulator position.

The soft light pressure will need adjusting as follows:

- Turn off electrical supply;
- referring to diagram 5, open the dust cap of the soft light regulator, by unscrewing in clockwise direction the white screw;
- turn the adjustment screw one step in the direction max to increase or in the direction min to decrease the soft light pressure;
- after each adjustment of the regulator, turn on the electrical supply and recheck burner ignition (wait 20 seconds between each cycle to allow the gas valves' internal servo system to reset). When the required level is achieved, close the dust cap.

7. Remove the pipe from the pressure gauge and connect screw "C" to the pressure outlet in order to seal off the gas.
8. Carefully check the pressure outlets for gas leaks (valve inlet and outlet).

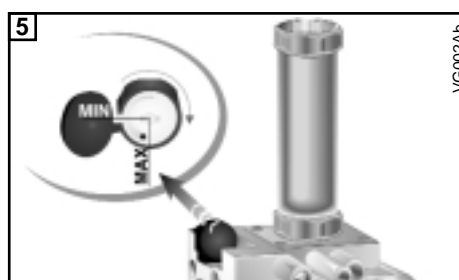

#### **IMPORTANT!**

Whenever you disassemble and reassemble the gas connections, always check for leaks using an approved soap and water solution.



**Regulating the heating power for natural gas (G20)**

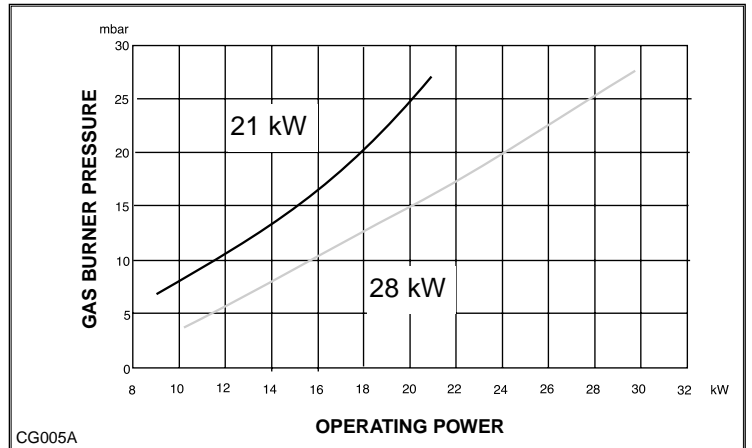

**Regulating the heating power for butane gas (G30)**

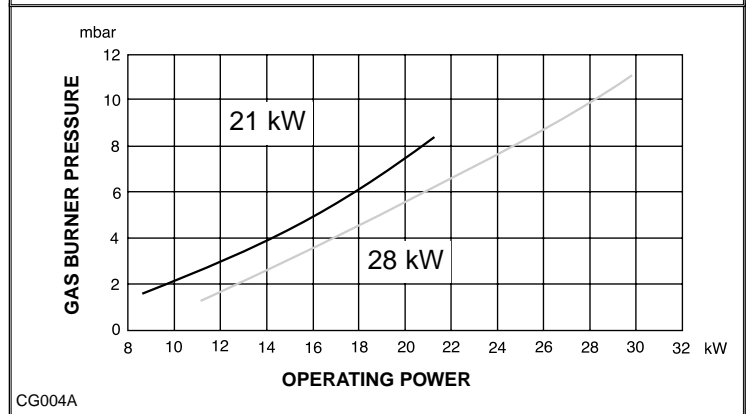

**Regulating the heating power for propane gas (G31)**

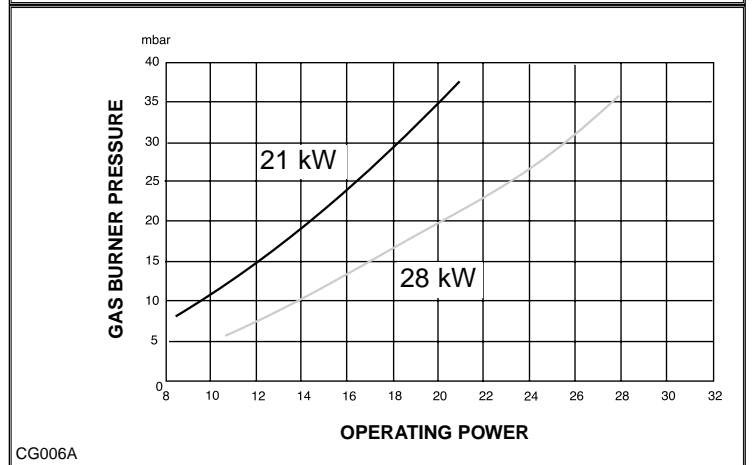
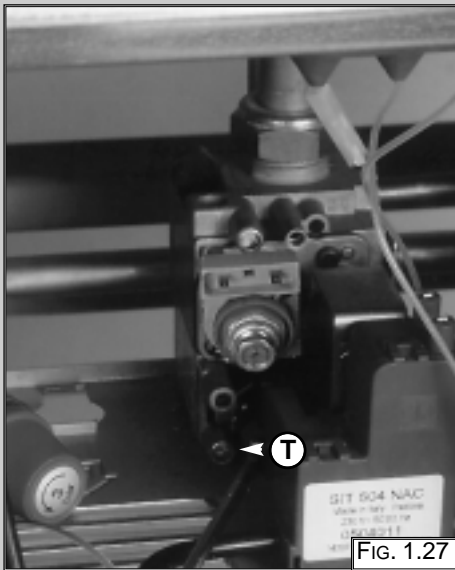
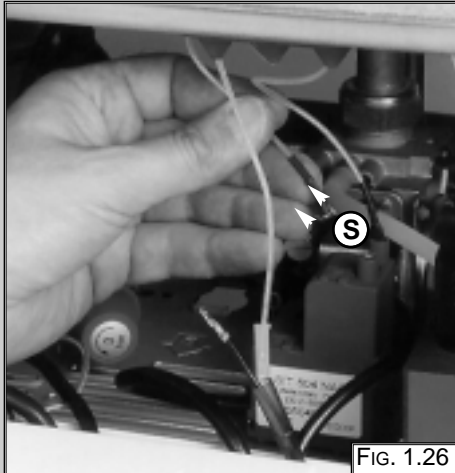

TABLE A

SYSTEM	GAS REQUIREMENTS		NATURAL GAS (G20)		BUTANE GAS (G30)		PROPANE GAS (G31)	
	Gas rate	max	2.4 m <sup>3</sup> /h	84.7 ft <sup>3</sup> /h	1.78 m <sup>3</sup> /h	62.8 ft <sup>3</sup> /h	1.76 m <sup>3</sup> /h	62.1 ft <sup>3</sup> /h
21 RFFI	Gas rate	min	1.05 m <sup>3</sup> /h	37.0 ft <sup>3</sup> /h	0.78 m <sup>3</sup> /h	27.5 ft <sup>3</sup> /h	0.77 m <sup>3</sup> /h	27.2 ft <sup>3</sup> /h
	Inlet pressure		20 mbar	7.8 in w.g.	28 mbar	10.9 in w.g.	37 mbar	14.4 in w.g.
	Burner pressure	max	8.5 mbar	3.3 in w.g.	27.5 mbar	10.7 in w.g.	37.4 mbar	14.6 in w.g.
	Burner pressure	min	1.7 mbar	0.7 in w.g.	6.2 mbar	2.4 in w.g.	8.0 mbar	3.1 in w.g.
	Burner jets		12 x 1.30		12 x 0.77		12 x 0.77	
	28 RFFI	Gas rate	max	3.15 m <sup>3</sup> /h	111.1 ft <sup>3</sup> /h	2.34 m <sup>3</sup> /h	82.6 ft <sup>3</sup> /h	2.31 m <sup>3</sup> /h
Gas rate		min	1.26 m <sup>3</sup> /h	44.5 ft <sup>3</sup> /h	0.94 m <sup>3</sup> /h	33.2 ft <sup>3</sup> /h	0.93 m <sup>3</sup> /h	32.8 ft <sup>3</sup> /h
Inlet pressure			20 mbar	7.8 in w.g.	28 mbar	10.9 in w.g.	37 mbar	14.4 in w.g.
Burner pressure		max	11 mbar	4.3 in w.g.	27.7 mbar	10.8 in w.g.	35.5 mbar	13.8 in w.g.
Burner pressure		min	1.6 mbar	0.6 in w.g.	4.6 mbar	1.8 in w.g.	6.0 mbar	2.3 in w.g.
Burner jets			14 x 1.30		14 x 0.77		14 x 0.77	

### 1.4.2 Removing the spark generator

1. Disconnect ignition leads "S" by pulling upward (FIG. 1.26);
2. Remove the screw "T" (FIG. 1.27);
3. Remove the spark generator by pulling forward from the gas valve.



### 1.4.3 Removing the gas valve

***Important!*** Before removing the gas valve, ensure the gas supply is turned off.

1. Disconnect all the cables from the solenoid and modureg;
2. Remove the spark generator (see previous section);
3. Release the top nut "U" (FIG. 1.28);
4. Remove the screws "V" from the bottom of the gas valve pipe (FIG. 1.29);
5. Remove the gas valve (FIG. 1.30).

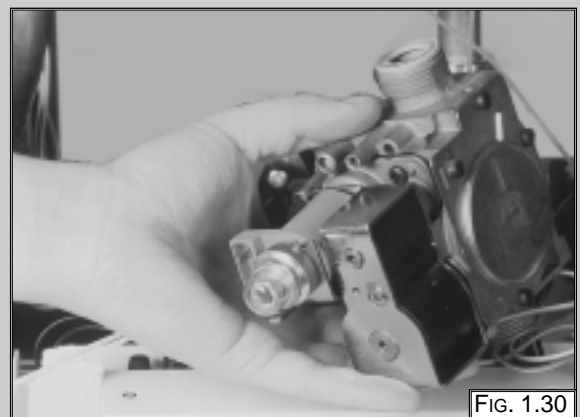
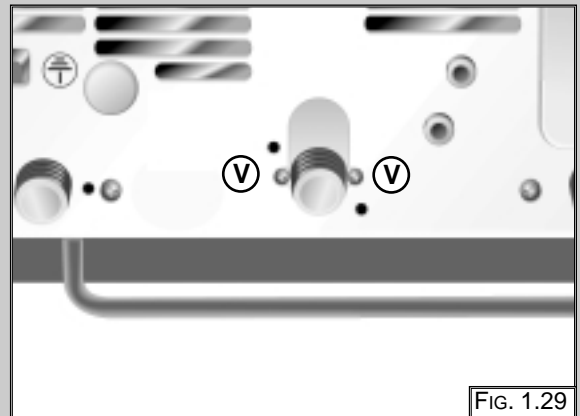
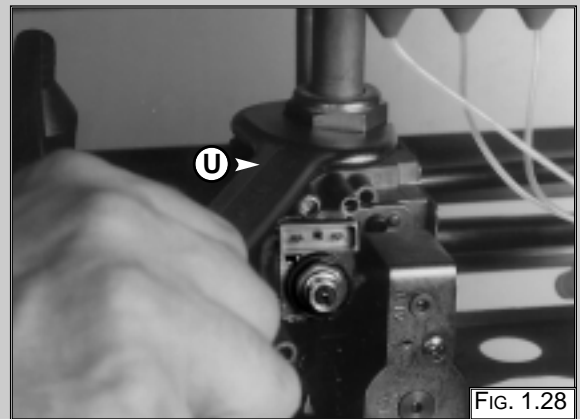

## 1.5 ACCESS TO THE WATER CIRCUIT

**Important!** Before any component is removed, the boiler must be drained of all water.

### 1.5.1 Removing the pump pressure switch

1. Remove the cable of the pump pressure switch "W" (Fig. 1.31);
2. Unscrew the pump pressure switch by using a spanner on the nut "X"(Fig. 1.32);
3. Remove the pump pressure switch.

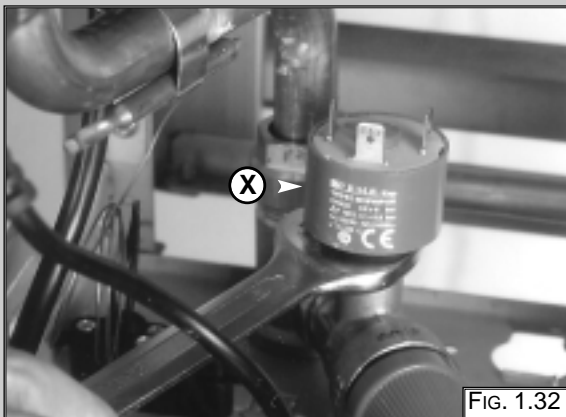
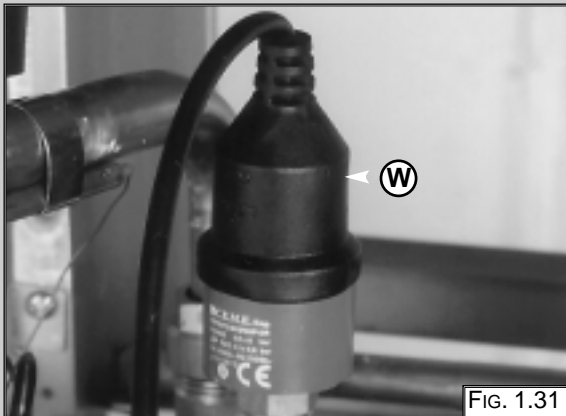

### 1.5.2 Removing the safety valve

1. Loosen nut "Y" (Fig. 1.33);
2. Disconnect the discharge pipe work from below the boiler;
3. Unscrew and remove the valve.

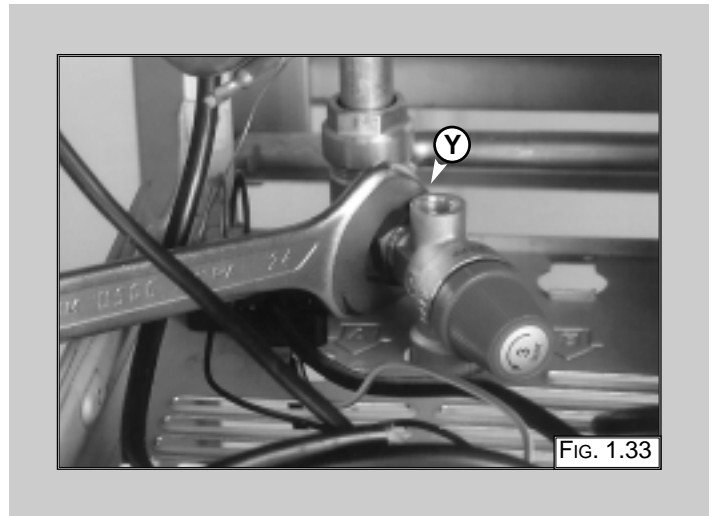

### 1.5.3 Removing the automatic air vent

1. Unscrew valve top "Z" (Fig. 1.34);
2. Remove valve complete with float (Fig 1.35).

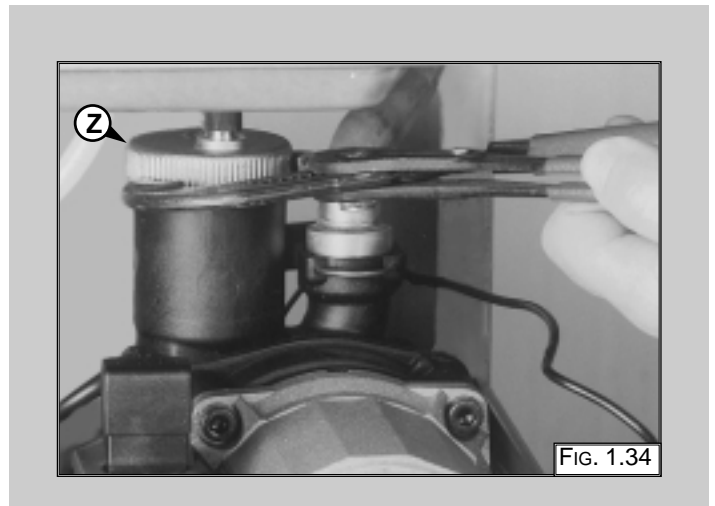

### 1.5.4 Removing the pump

1. Remove the U-clips "A1" and "B1" (FIG. 1.36);
2. Remove the retaining clip "C1" (FIG. 1.37);
3. Release the nut "D1" (FIG. 1.38);
4. Remove the pipe "E1" (FIG. 1.39);
5. Remove the screw "F1" (FIG. 1.40);
6. Remove the pump (FIG. 1.41).

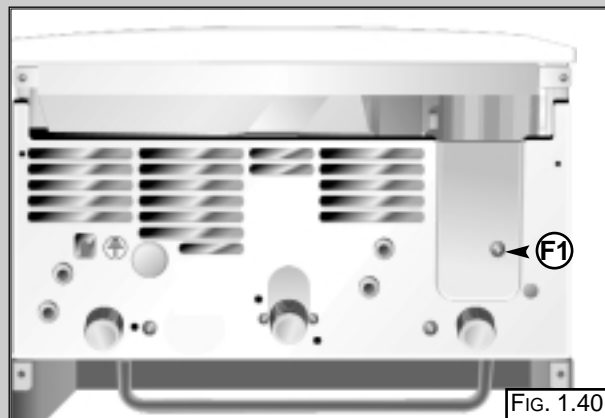
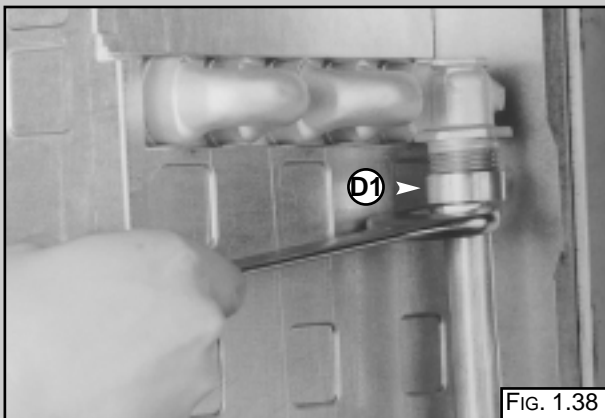
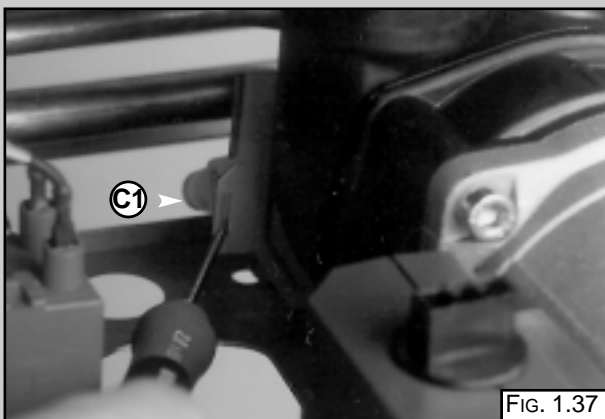
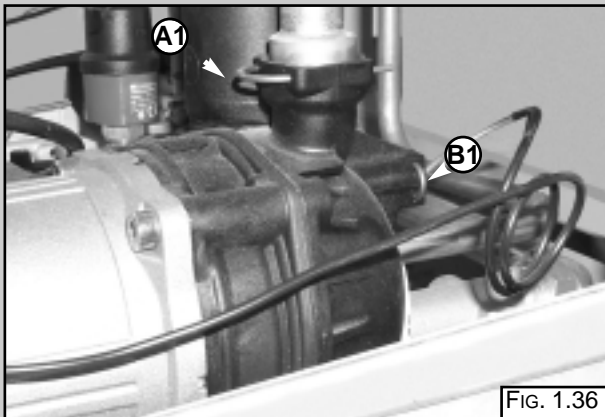

### 1.5.5 Removing the pressure gauge

1. Remove the U-clip "G1" and remove the pressure gauge coupling (FIG. 1.42);
2. Push the pressure gauge through the control panel from the rear (FIG. 1.43).

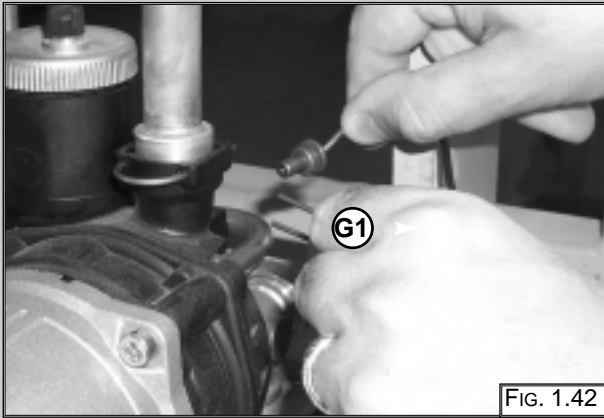

### 1.5.6 Removing the expansion vessel

1. Release nuts "H1" and remove the gas pipe (FIG. 1.44);
2. Release nut "I1" (FIG. 1.45);
3. Remove lock-nut "J1" (FIG. 1.46);
4. Remove the expansion vessel (FIG. 1.47).

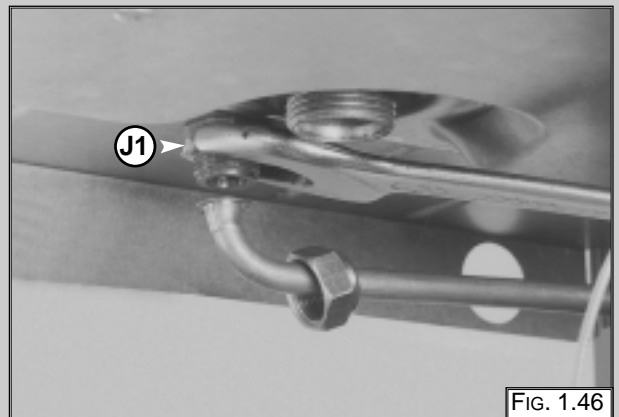
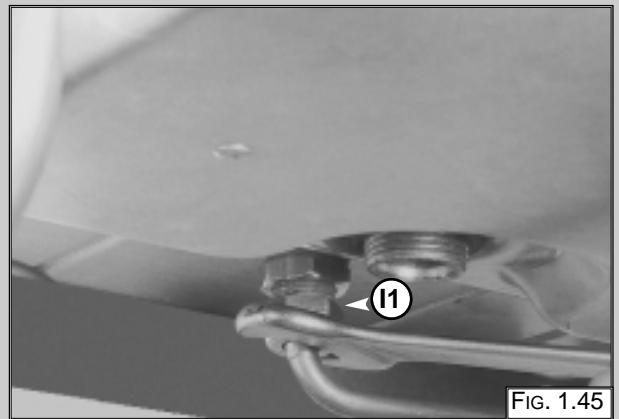
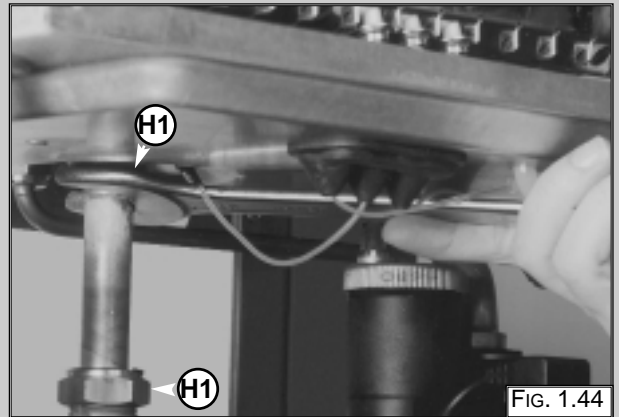

### 1.5.6 Removing the overheat thermostat

1. Disconnect the overheat thermostat electrical connections "K1" (FIG. 1.48);
2. Then remove the thermostat from its mounting by releasing the securing clip (FIG. 1.49).

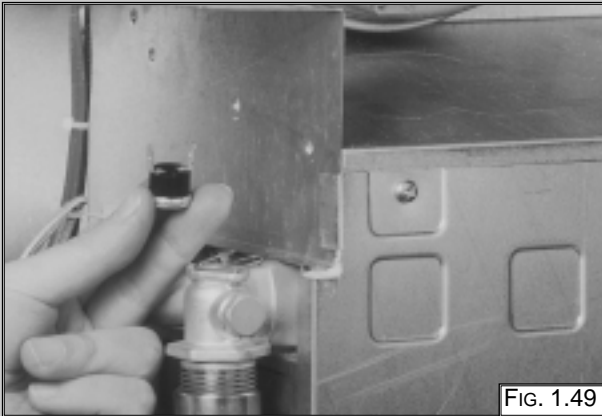
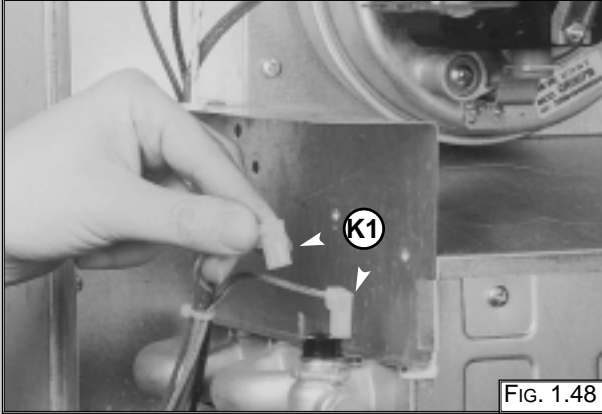

### 1.5.7 Removing the frost thermostat

1. Disconnect the frost thermostat electrical connection "L1" (FIG. 1.50);
2. Then remove the thermostat from its mounting by releasing the securing clip (FIG. 1.51).

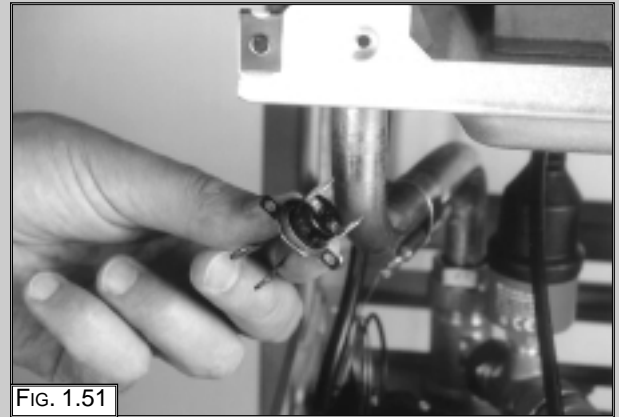
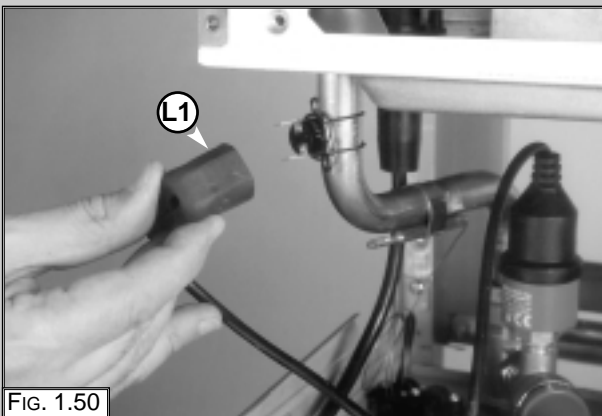

### 1.5.8 Removing the regulation thermostat

1. Remove the regulation thermostat sensor from its mounting by releasing the securing clip "M1" (FIG. 1.52);
2. Separate the fascia panel from the rear of the control panel (see section 1.6.2);
3. Remove the electrical connections "N1" from the regulation thermostat (FIG. 1.53);
4. Pull the regulation knob from the spindle of the thermostat;
5. Remove the thermostat from the control panel fascia by unscrewing the mounting screws.

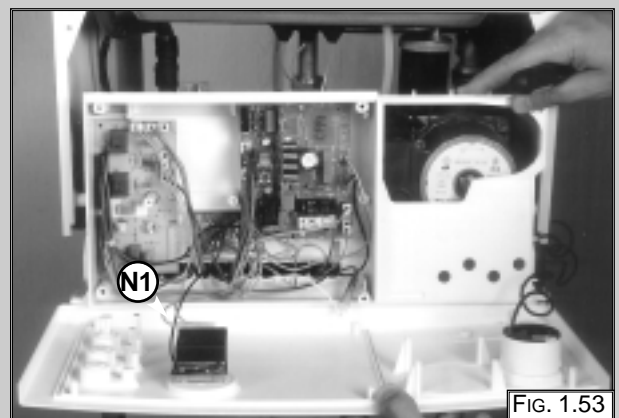
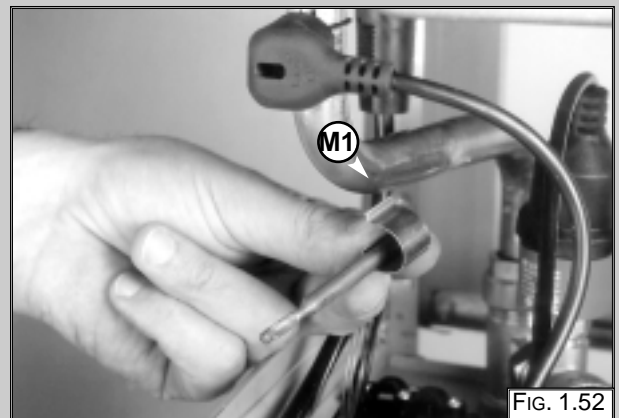

## 1.6 ACCESS TO THE CONTROL SYSTEM

**Important!** Isolate the electrical supply to the boiler before accessing the control panel.

### 1.6.1 Checking the fuse

1. Remove the inspection cover on the reverse of the control panel (FIG. 1.54);
2. Remove the fuse mounted on the reverse of the inspection cover (FIG. 1.55).

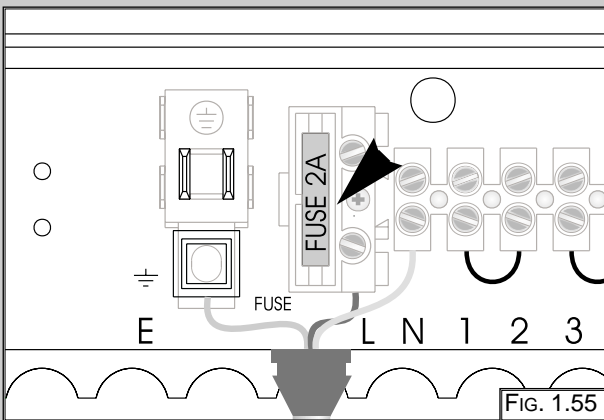
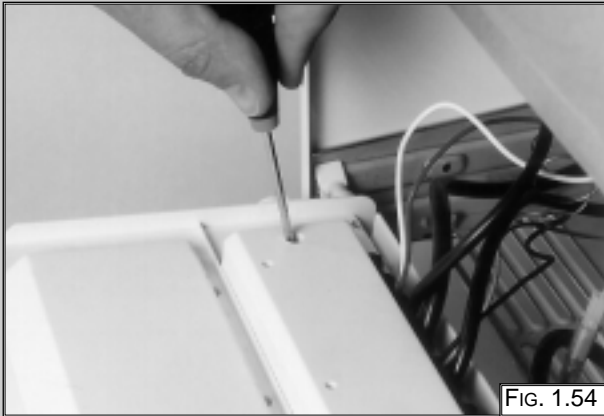

### 1.6.2 Removing the P.C.B.s

1. Isolate electricity;
2. Remove the screws "O1" (FIG. 1.56);
3. Separate the fascia panel from the rear of the control panel;
4. Unplug all electrical connections from the P.C.B. and remove the screws "P1" and remove the P.C.B. (FIG. 1.57).

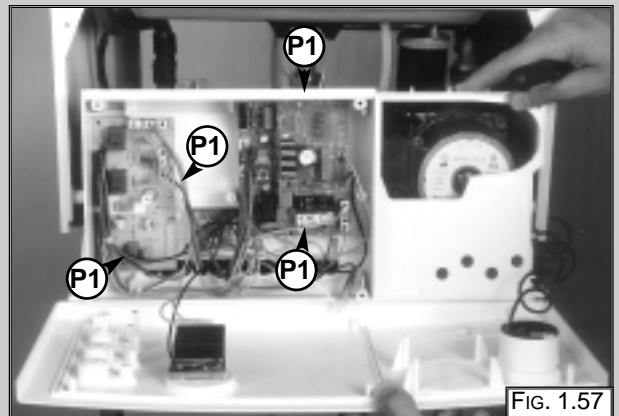
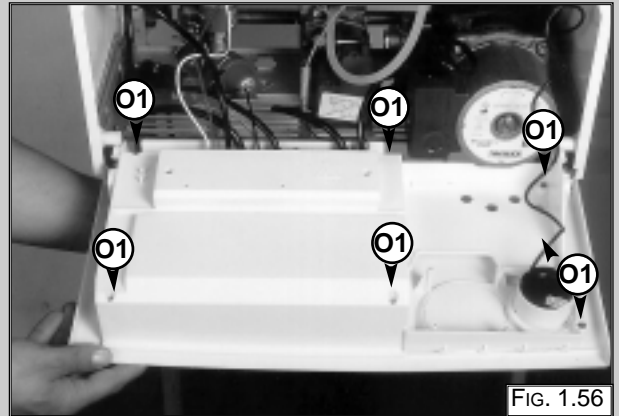

## 2. FAULT FINDING

### 2.1 FAULT FINDING GUIDE (FLOW-CHARTS)

It is possible to detect and correct any defect by using the standard fault finding diagrams described in this chapter.

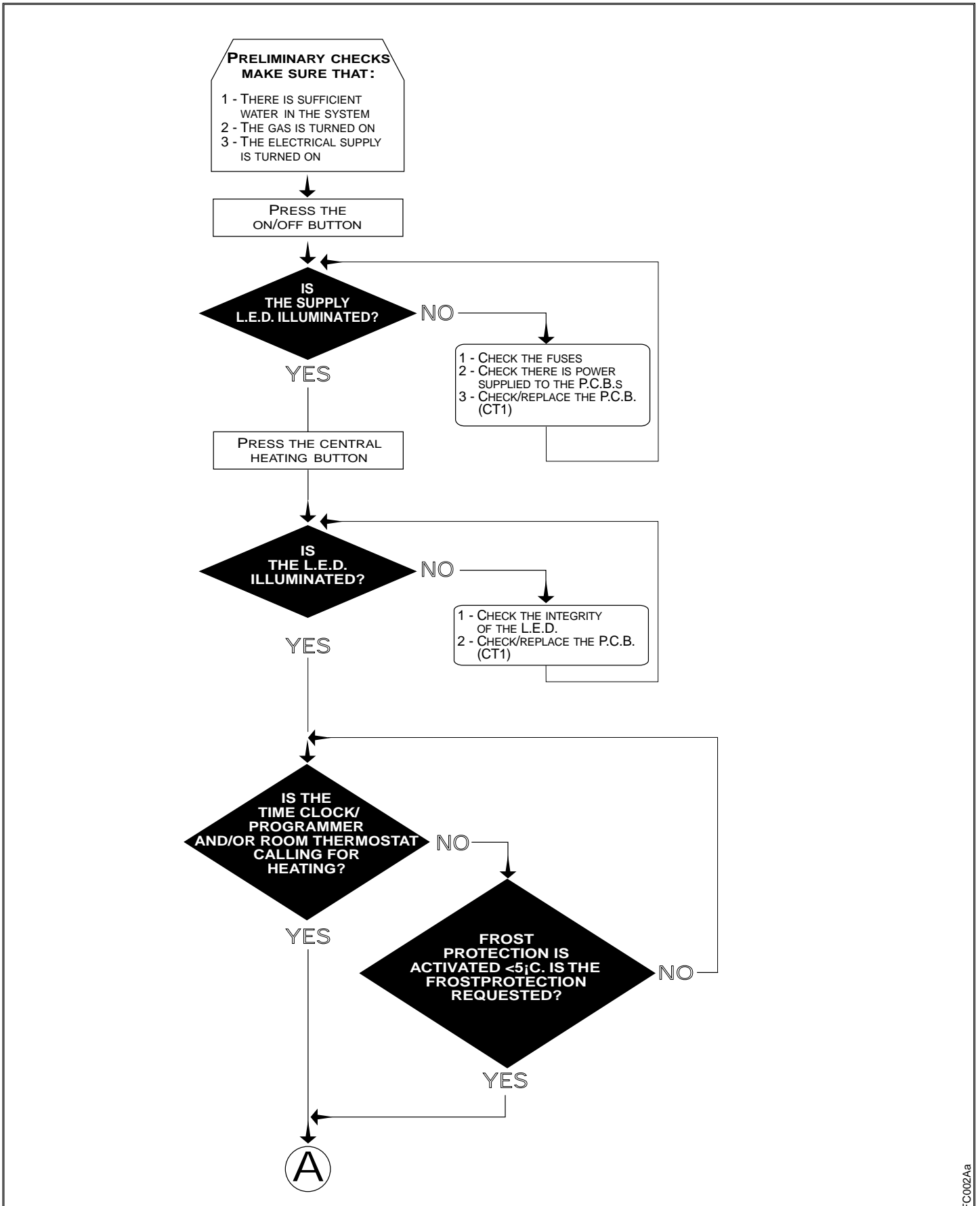



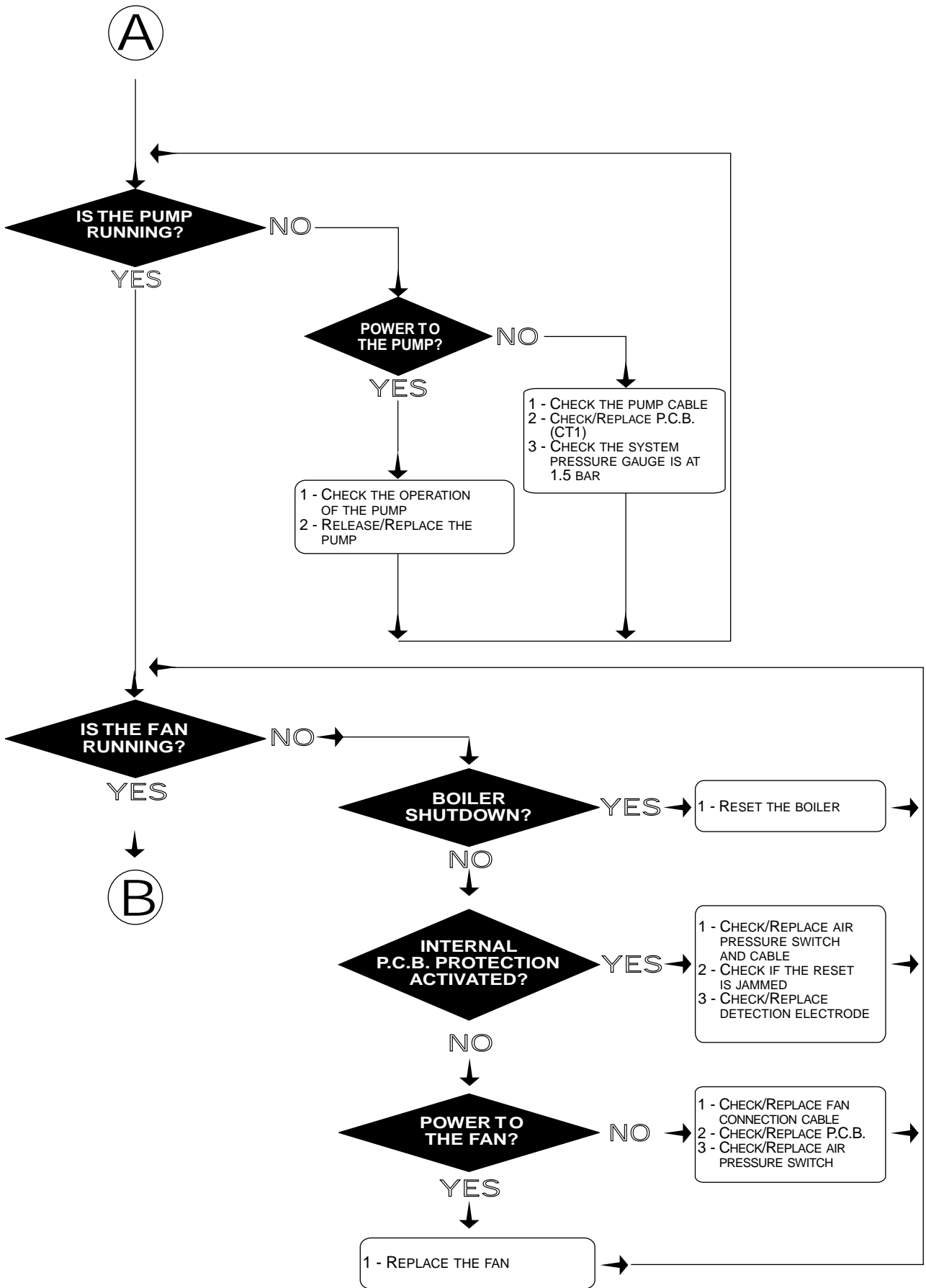

(B)

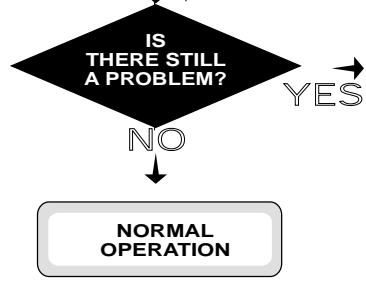
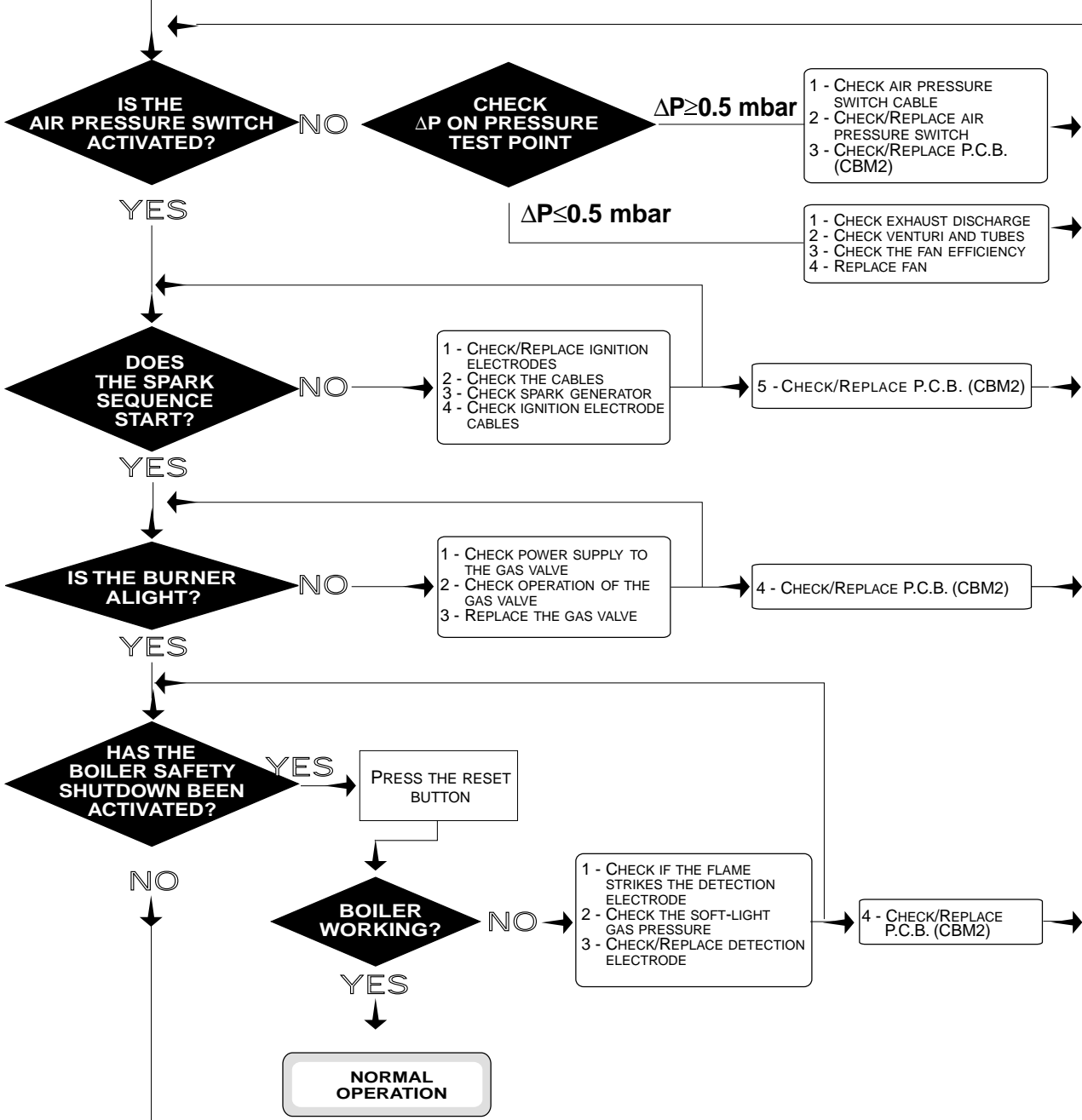

	<i>FAULT LIST</i>	<i>POSSIBLE CAUSES</i>
1	NOISEY OPERATION	<ul style="list-style-type: none"> <li>- MAIN HEAT EXCHANGER FAULTY OR BLOCKED WITH LIME-SCALE DEPOSITS</li> <li>- LOW HEATING SYSTEM WATER PRESSURE</li> <li>- CHECK GAS PRESSURES</li> <li>- CHECK HEATING THERMOSTAT</li> <li>- CHECK FAN</li> <li>- CHECK PUMP</li> </ul>
2	DECREASE/INCREASE OF HEATING CIRCUIT PRESSURE	<ul style="list-style-type: none"> <li>- CHECK FOR LEAKS ON THE HEATING CIRCUIT</li> <li>- FAULTY FILLING LOOP</li> <li>- FAULTY EXPANSION VESSEL</li> </ul>
3	REPEATED SHUTDOWNS	<ul style="list-style-type: none"> <li>- FAULTY DETECTION ELECTRODES</li> <li>- CHECK GAS PRESSURES</li> <li>- CHECK FLAME DETECTION ELECTRICAL CIRCUIT</li> </ul>
4	REPEATED OPERATION OF SAFETY THERMOSTAT	<ul style="list-style-type: none"> <li>- FAULTY HEATING THERMOSTAT</li> <li>- FAULTY OVERHEAT THERMOSTAT</li> <li>- PRESENCE OF AIR IN THE HEATING CIRCUIT</li> <li>- CHECK BURNER PRESSURES</li> <li>- CHECK EXCHANGER FLUEWAY</li> </ul>
5	INSUFFICIENT RADIATOR TEMPERATURE	<ul style="list-style-type: none"> <li>- CHECK HEATING THERMOSTAT</li> <li>- CHECK BY-PASS</li> <li>- CHECK GAS PRESSURE</li> </ul>

### 3. ELECTRICAL DIAGRAMS

**LEGEND:**

- A - On/Off Switch
- B - On/Off L.E.D.
- C - Heating Switch
- D - Heating L.E.D.
- E - Reset Button
- F - Ignition Failure (Lockout) L.E.D.

- A01 - Pump Pressure Switch
- A02 - Frost Thermostat
- A03 - Modulator
- A04 - Circulation Pump
- A05 - Regulation Thermostat

- A06 - External Control System
- A07 - Time Clock Connector
- A08 - External (Room) Thermostat
- A09 - Air Pressure Switch
- A10 - Fan
- A11 - Overheat Thermostat
- A12 - Spark Generator/Gas Valve Supply
- A13 - Detection Electrode

- Colours:**
- Wh -White
  - Bl -Blue
  - Gry -Grey
  - Brn -Brown
  - Blk -Black
  - Rd -Red
  - Grn/Yll -Yellow/Green

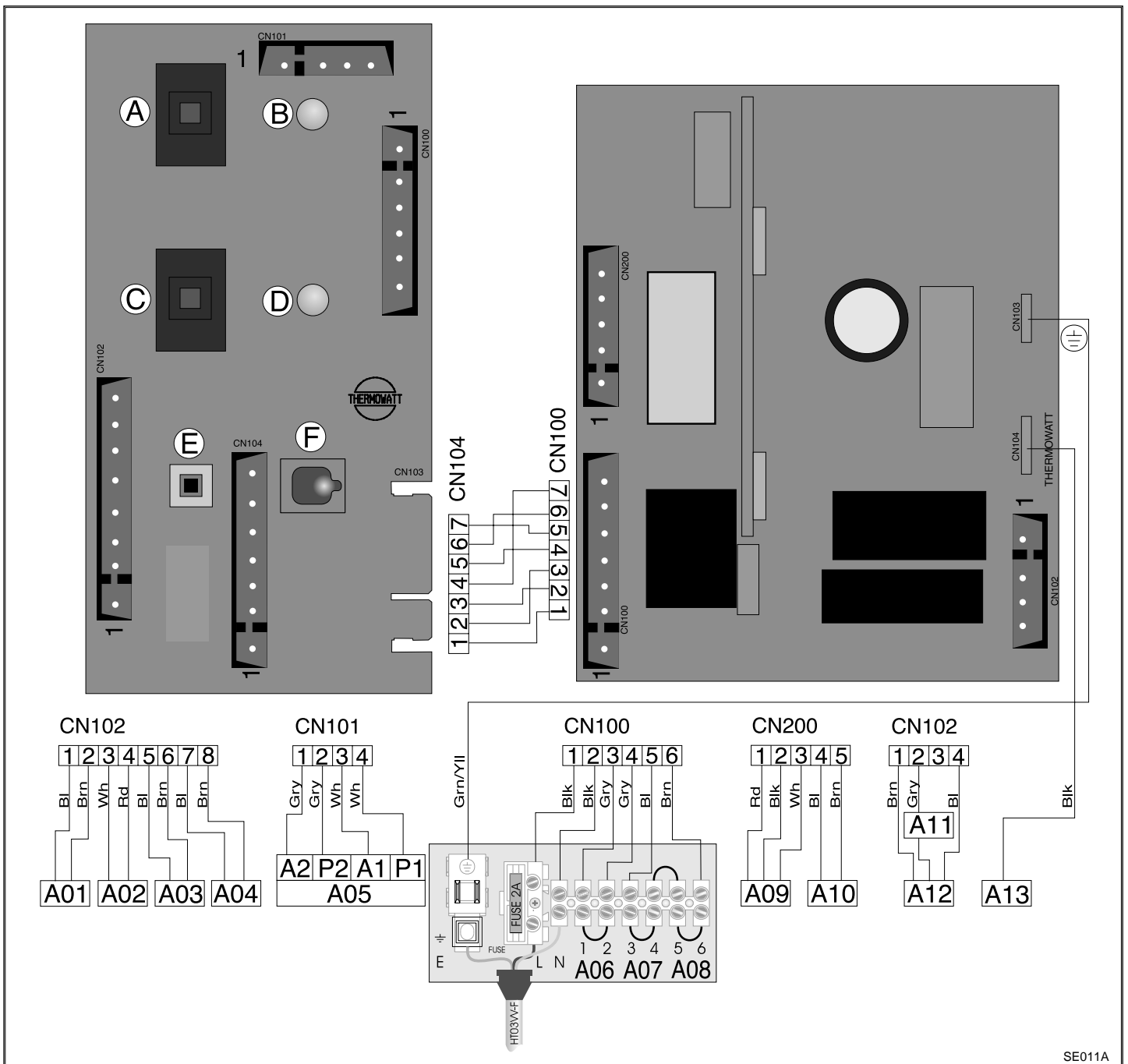

SE011A

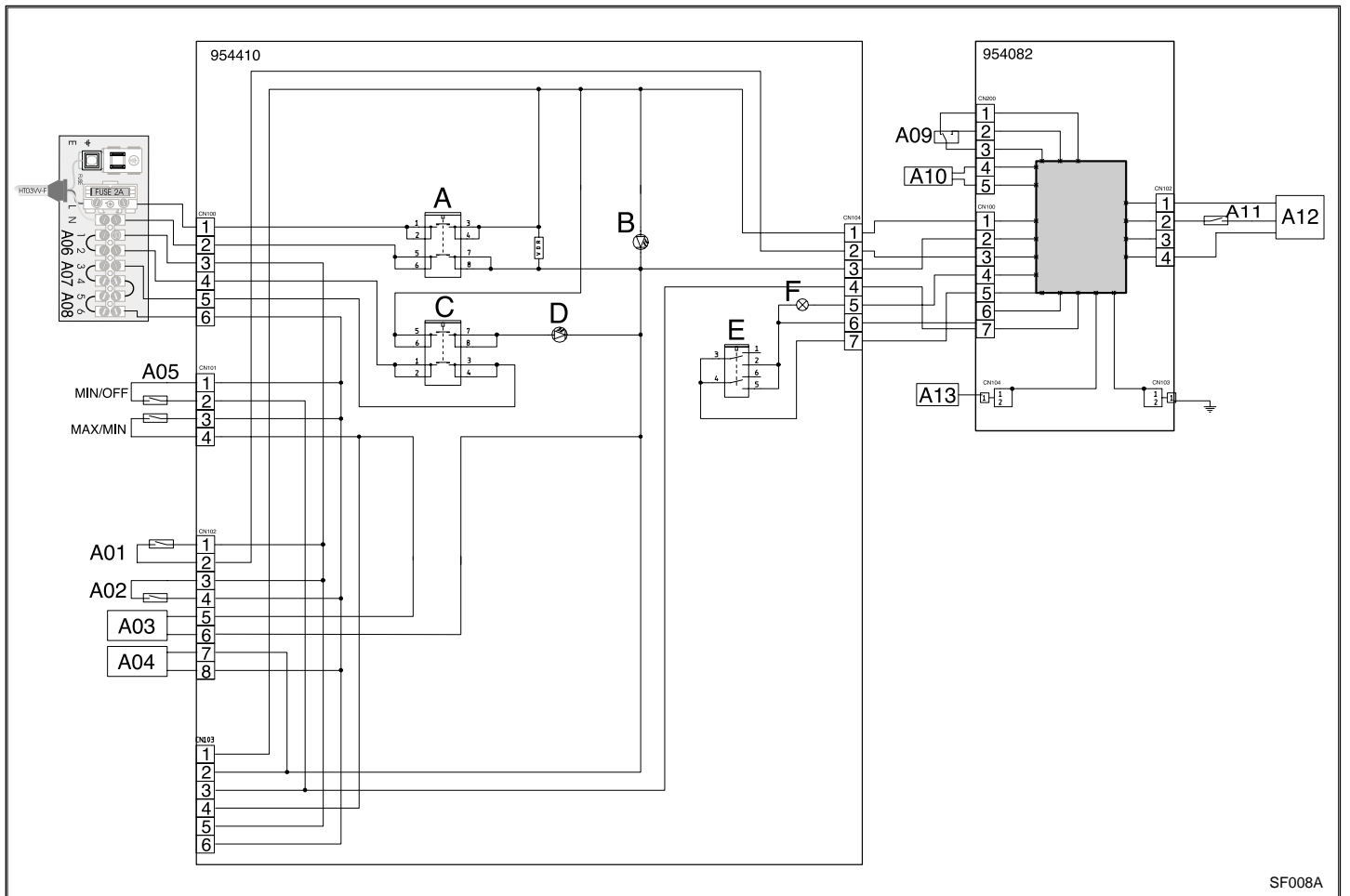

SF008A

# 4. SHORT SPARE PARTS LIST

## microSYSTEM 21/28 RFFI

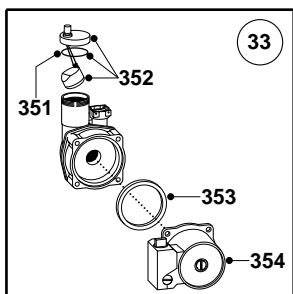
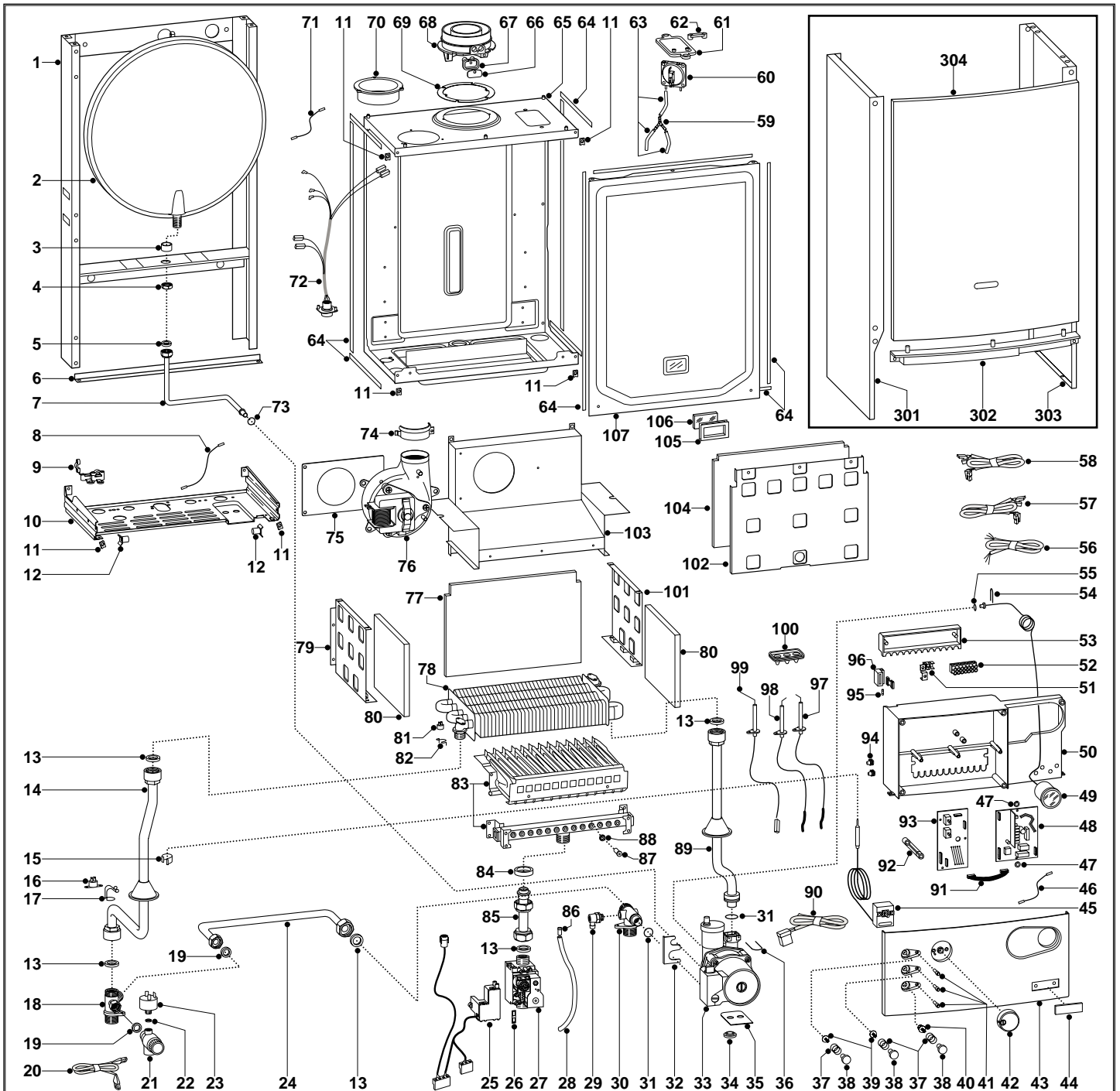

**microSYSTEM 21/28 RFFI**

Key no.	G.C. part no.	Description	ARISTON Part No.
2		Expansion vessel	998616
5	164 282	Gasket 3/8"	573521
13	164 225	Gasket 3/4"	573520
16		Thermostat (frost)	570760
18		Flow group	998612
19	164 229	Gasket 1/2"	573528
21		Safety valve (1/4" 3 bar)	998447
22	164 261	Gasket 1/4"	569390
23		Pump pressure switch	998627
25		Spark Generator	999542
26		Gasket	574279
27		Gas valve	999475
29		Auto air vent	998809
30		Return group	999476
31		O-ring	998424
33AB		Pump	998836
33CD		Pump	999091
45		Thermostat (regulation)	999577
48		P.C.B. (CBM2 AT-FFI2X)	999499
49		Pressure gauge	999245
55		Gasket	998517
60AB		Air pressure switch	998484
60CD	E03 818	Air pressure switch	571651
73		Gasket	997182
75		O-ring (2.65 x 10.27)	998943
76AB		Fan	998489
76CD		Fan	999894
78AB		Main exchanger	998620
78CD		Main exchanger	998893
81		Thermostat (overheat)	999538
83A		Burner 12 ramp (natural gas)	998618
83B		Burner 12 ramp (LPG)	998669
83C		Burner 14 ramp (natural gas)	998887
83D		Burner 14 ramp (LPG)	998939
87AC		Burner jet (natural gas 1.30)	998433
87BD		Burner jet (LPG 0.77)	998434
93		P.C.B. (CT1)	999501
95		Fast fuse 2AT	950030
97		Electrode (ignition R.H.)	998623
98		Electrode (ignition L.H.)	998622
99		Detection electrode	998624
351		O-ring (A.A.V.)	998644
352		Auto air vent	998643
353		Gasket (pump head)	998738
354AB		Pump head	998961
354CD		Pump head	999207
361	E24 076	Burner jet 1.30 full kit (natural gas)	998716
362	E24 075	Burner jet 0.77 full kit (LPG)	998717



Manufacturer: **Merloni TermoSanitari SpA - Italy**

Commercial subsidiary: **MTS (GB) LIMITED**

MTS Building  
Hughenden Avenue  
High Wycombe  
Bucks HP13 5FT

Telephone: (01494) 755600

Fax: (01494) 459775

Internet: <http://www.mtsgb.ltd.uk>

E-mail: [info@mtsgb.ltd.uk](mailto:info@mtsgb.ltd.uk)

**Technical Service Hot Line: (01494) 539579**